









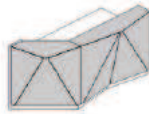
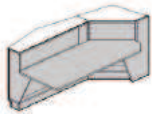

SPECYFIKACJA TECHNICZNA

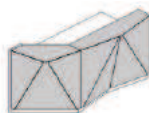
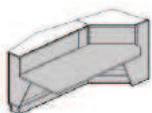
KOLORYSTYKA

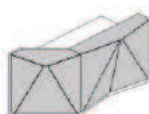
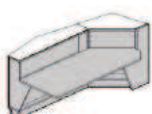
FRONT, BLAT GÓRNY, KORPUS, NOGA PODPIERAJĄCA NG41

			
67 BIAŁY PASTEL	BIAŁY, SZKŁO HARTOWANE		
			
08 CZARNY	CZARNY, SZKŁO HARTOWANE		
			
26 ALUMINIUM SATINATO	SREBRNY, SZKŁO HARTOWANE		
			
M009 ALUMINIUM PÓŁMAT	M015 BIAŁY PÓŁMAT	M115 CZARNY PÓŁMAT	

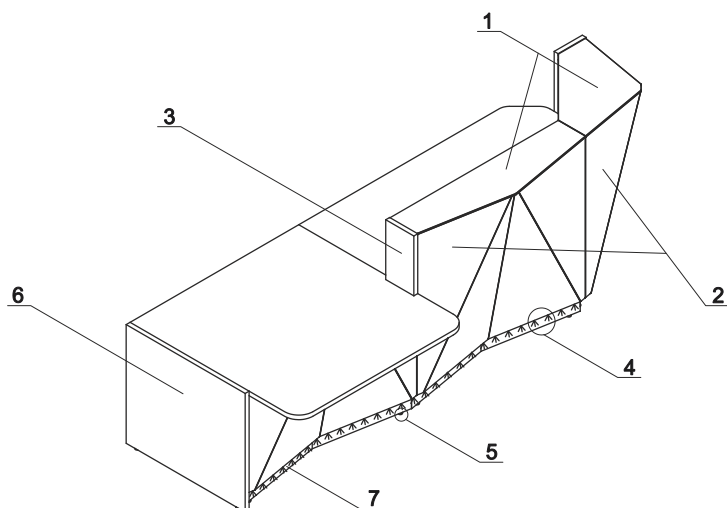

1. **Blat górny** - płyta melaminowana 28mm, szkło hartowane 8mm
2. **Front** - płyta melaminowana 12 mm + szkło LACOBEL 4mm
3. **Bok łączący lady niskie i wysokie** - płyta melaminowana 28mm, obrzeża PVC
4. **Oświetlenie LED** - na całej długości lady, barwa biała-zimna (wpada lekko w odcień niebieski)
5. **Regulator poziomy** - regulacja w zakresie 5mm
6. **Noga boczna niska** - płyta melaminowana 28mm, obrzeża PVC
7. **Cokół** - HPL - aluminium szczotkowane

SPECYFIKACJA TECHNICZNA

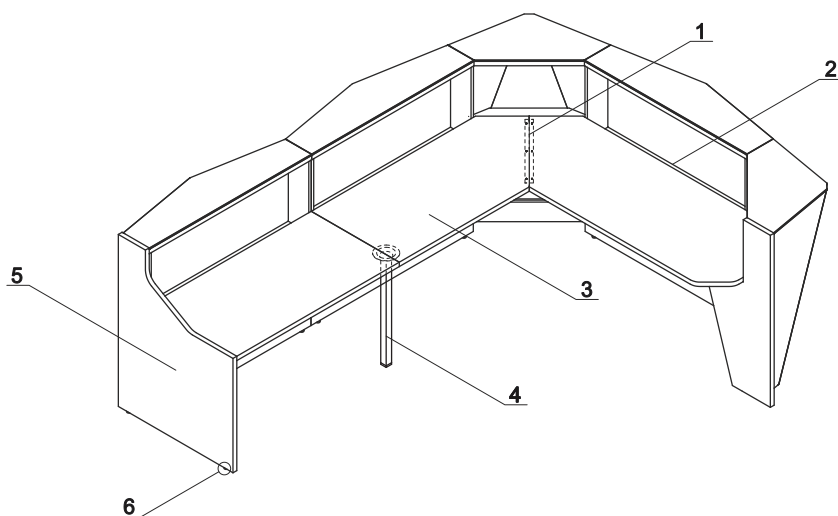

1. **Płaskownik mocujący**
2. **Półka pod monitor** - płyta melaminowana 28mm
3. **Błat roboczy** - płyta melaminowana 28mm, obrzeża PVC
4. **Noga podpierająca NG41** - metal malowany proszkowo, wymagana na łączeniu blatów
5. **Noga boczna wysoka** - płyta melaminowana 28mm, obrzeża PVC
6. **Regulator poziomu** - regulacja w zakresie 5mm

ZASTOSOWANIE ELEMENTÓW KOŃCĄCYCH

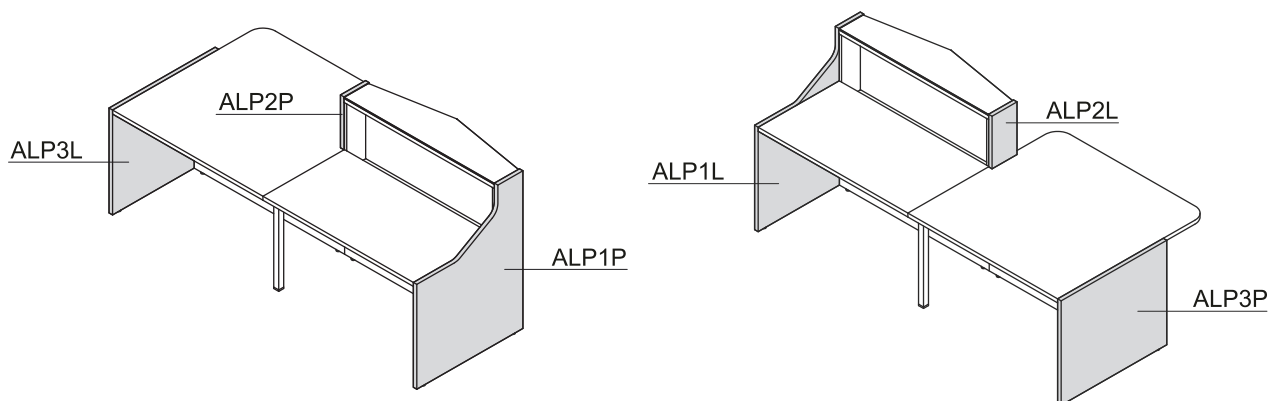

WYMIARY

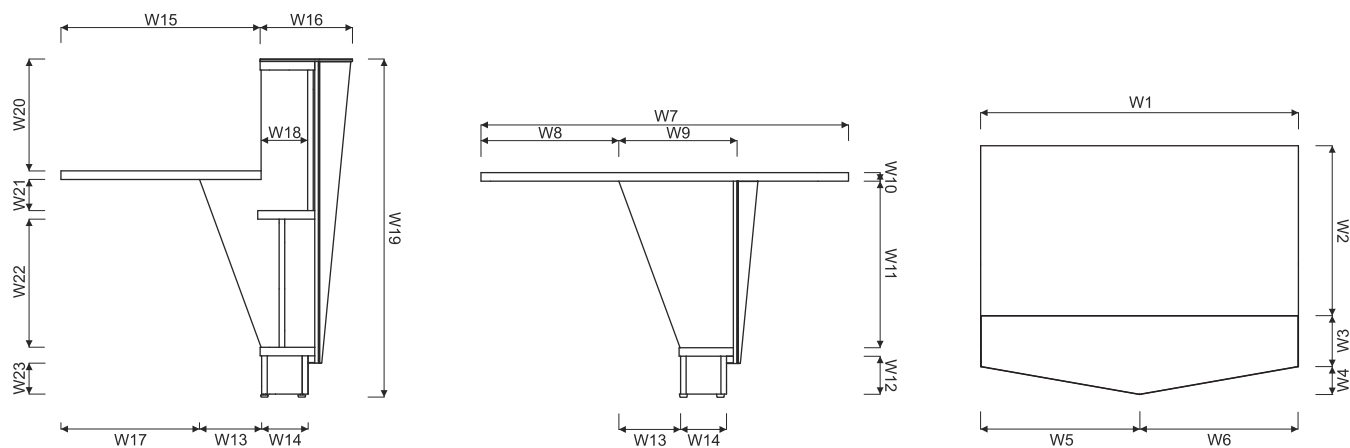

W1 - 1199mm | W2 - 650mm | W3 - 194mm | W4 - 106mm | W5 - 608mm | W6 - 608mm | W7 - 1200mm | W8 - 448mm | W9 - 353mm | W10 - 28mm |
 W11 - 549mm | W12 - 125mm | W13 - 199mm | W14 - 150mm | W15 - 650mm | W16 - 300mm | W17 - 449mm | W18 - 151mm | W19 - 1106mm |
 W20 - 366mm | W21 - 102mm | W22 - 424mm | W23 - 125mm

UKŁADY LAD

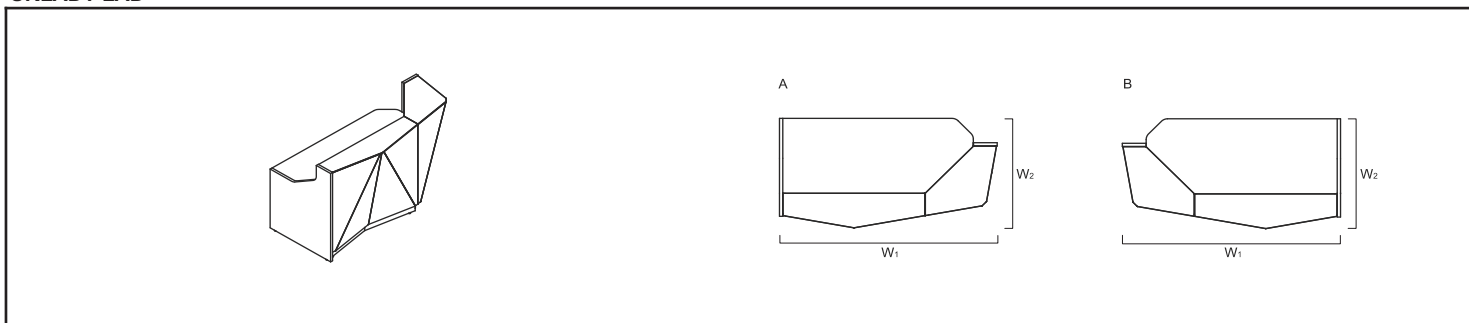

SYMBOL	WYMIARY [mm]						kg	m3	szt	ELEMENTY SKŁADOWE
	W ₁	W ₂	D ₁	D ₂	H					
A ALP04L	1835	946	-	-	1100		103.0	1.047	7	ALP18L+ALP1P
B ALP04P	1835	946	-	-	1100		103.0	1.047	7	ALP1L+ALP18P

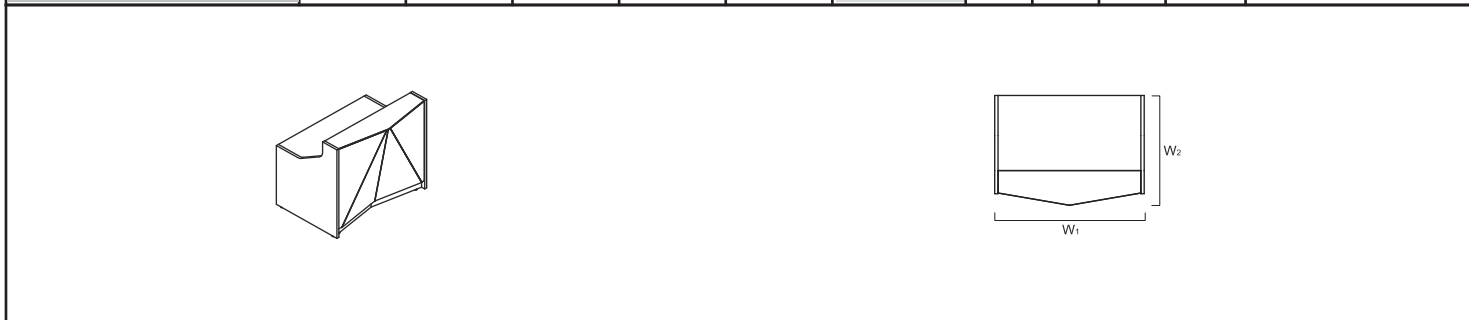

SYMBOL	WYMIARY [mm]						kg	m3	szt	ELEMENTY SKŁADOWE
	W ₁	W ₂	D ₁	D ₂	H					
ALP05	1256	946	-	-	1100		76.5	0.782	5	ALP1L+ALP12+ALP1P

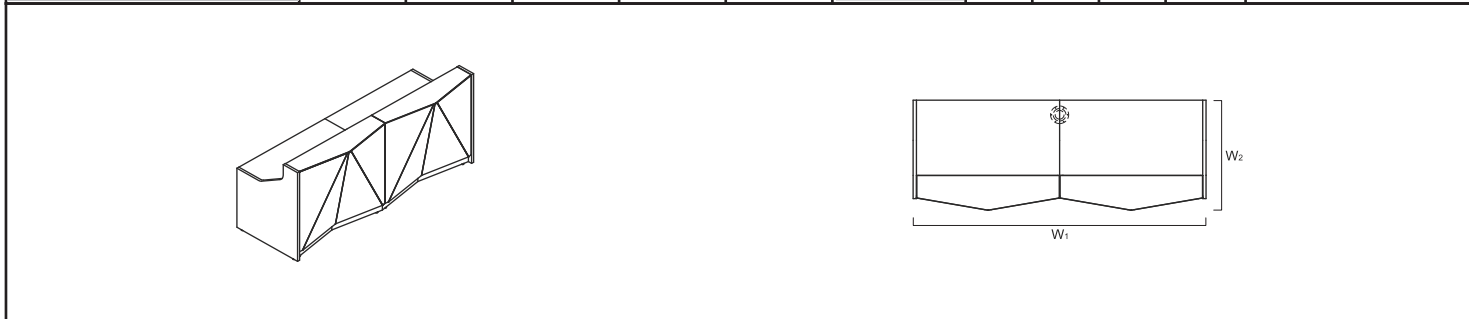

SYMBOL	WYMIARY [mm]						kg	m3	szt	ELEMENTY SKŁADOWE
	W ₁	W ₂	D ₁	D ₂	H					
ALP06	2456	946	-	-	1100		129.0	1.498	9	ALP1L+2xALP12+ALP1P+NG41

LEGENDA:

- WAGA NETTO

- OBJĘTOŚĆ

- ILOŚĆ PACZEK

UKŁADY LAD

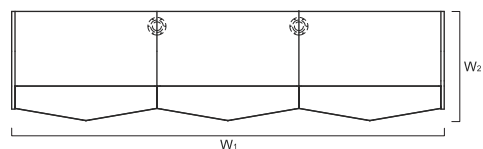
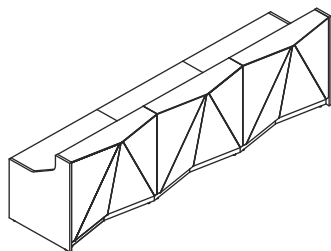

SYMBOL	WYMIARY [mm]						kg	m3	szt	ELEMENTY SKŁADOWE
	W ₁	W ₂	D ₁	D ₂	H					
ALP07	3656	946	-	-	1100		181.5	2.214	13	ALP1L+3xALP12+ALP1P+2xNG41

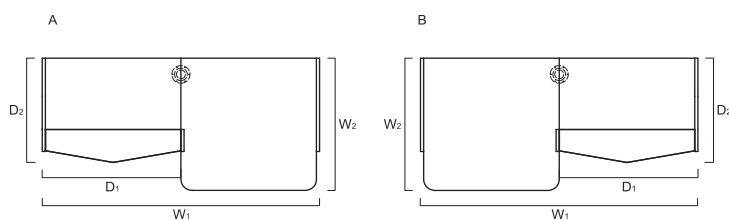
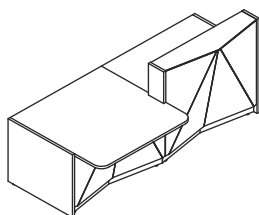

SYMBOL	WYMIARY [mm]						kg	m3	szt	ELEMENTY SKŁADOWE
	W ₁	W ₂	D ₁	D ₂	H					
A ALP21L	2456	1200	1228	950	1100		135.0	1.264	9	ALP3L+ALP11+ALP2P+ALP12+ALP1P+NG41
B ALP21P	2456	1200	1228	950	1100		135.0	1.264	9	ALP1L+ALP12+ALP2L+ALP11+ALP3P+NG41

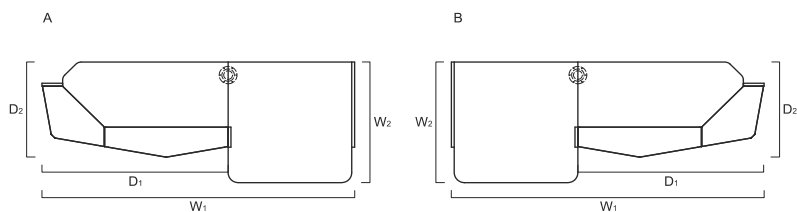
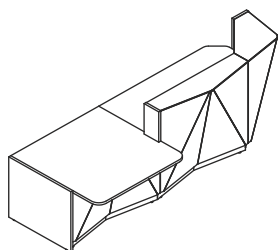

SYMBOL	WYMIARY [mm]						kg	m3	szt	ELEMENTY SKŁADOWE
	W ₁	W ₂	D ₁	D ₂	H					
A ALP22L	3034	1200	1806	950	1100		163.0	1.533	12	ALP3L+ALP11+ALP2P+ALP18P+NG41
B ALP22P	3034	1200	1806	950	1100		163.0	1.533	12	ALP18L+ALP2L+ALP11+ALP3P+NG41

LEGENDA:



- WAGA NETTO

- OBJĘTOŚĆ

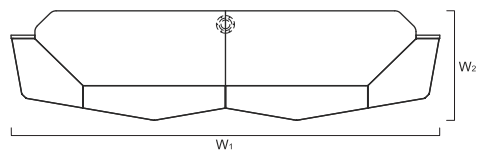
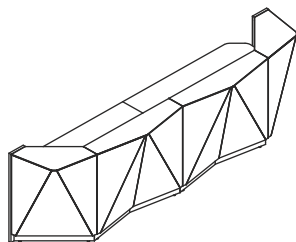

- ILOŚĆ PACZEK

UKŁADY LAD



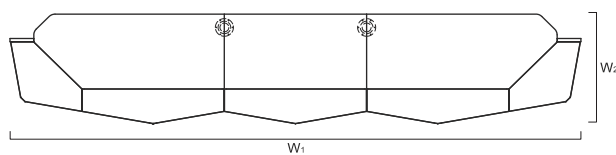
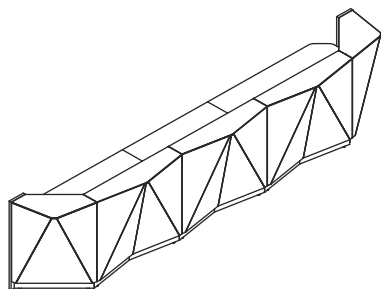

SYMBOL	WYMIARY					[mm]						ELEMENTY SKŁADOWE
	W ₁	W ₂	D ₁	D ₂	H							
ALP15	3613	946	-	-	1100			182.0	2.029	13		ALP18L+ALP18P+NG41

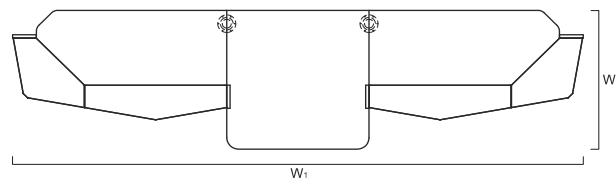
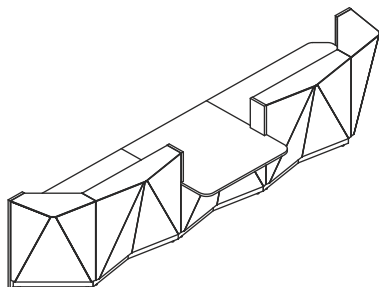

SYMBOL	WYMIARY					[mm]						ELEMENTY SKŁADOWE
	W ₁	W ₂	D ₁	D ₂	H							
ALP16	4813	946	-	-	1100			234.5	2.745	17		ALP18L+ALP12+ALP18P+2xNG41



SYMBOL	WYMIARY					[mm]						ELEMENTY SKŁADOWE
	W ₁	W ₂	D ₁	D ₂	H							
ALP25	4813	946	-	-	1100			244.5	2.530	19		ALP18L+ALP2L+ALP11+ALP2P+ALP18P+2xNG41

LEGENDA:

 - WAGA NETTO

 - OBJĘTOŚĆ

 - ILOŚĆ PACZEK

UKŁADY LAD



SYMBOL	WYMIARY [mm]						kg	m3	szt	ELEMENTY SKŁADOWE
	W ₁	W ₂	D ₁	D ₂	H					
ALP14	2514	2514	1568	1568	1100		210.5	2.307	14	

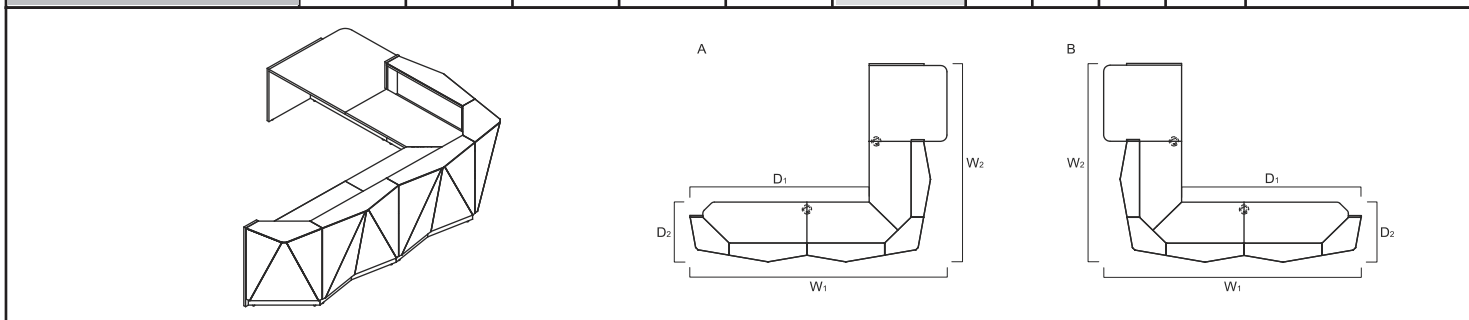

SYMBOL	WYMIARY [mm]						kg	m3	szt	ELEMENTY SKŁADOWE
	W ₁	W ₂	D ₁	D ₂	H					
A ALP24L	3967	3135	2768	950	1100		299.5	3.243	21	ALP3L+ALP11+ALP2P+ALP90+ ALP18P+2xNG41
B ALP24P	3967	3135	2768	950	1100		299.5	3.243	21	ALP18L+ALP90+ALP2L+ALP11+ ALP3P+2xNG41

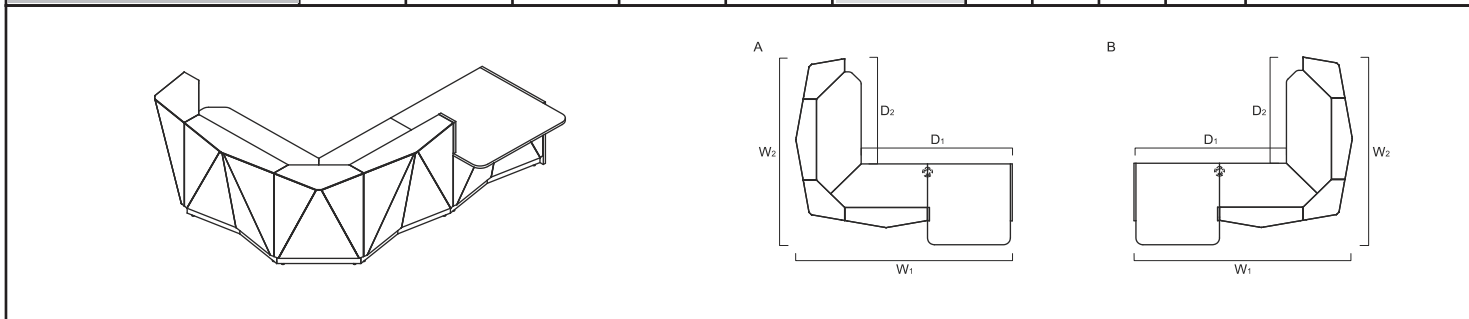

SYMBOL	WYMIARY [mm]						kg	m3	szt	ELEMENTY SKŁADOWE
	W ₁	W ₂	D ₁	D ₂	H					
A ALP23L	3135	2767	2189	1568	1100		245.5	2.527	17	ALP3L+ALP11+ALP2P+ALP19P+ NG41
B ALP23P	3135	2767	2189	1568	1100		245.5	2.527	17	ALP19L+ALP2L+ALP11+ALP3P+ NG41

LEGENDA:

- WAGA NETTO

- OBJĘTOŚĆ

- ILOŚĆ PACZEK

UKŁADY LAD

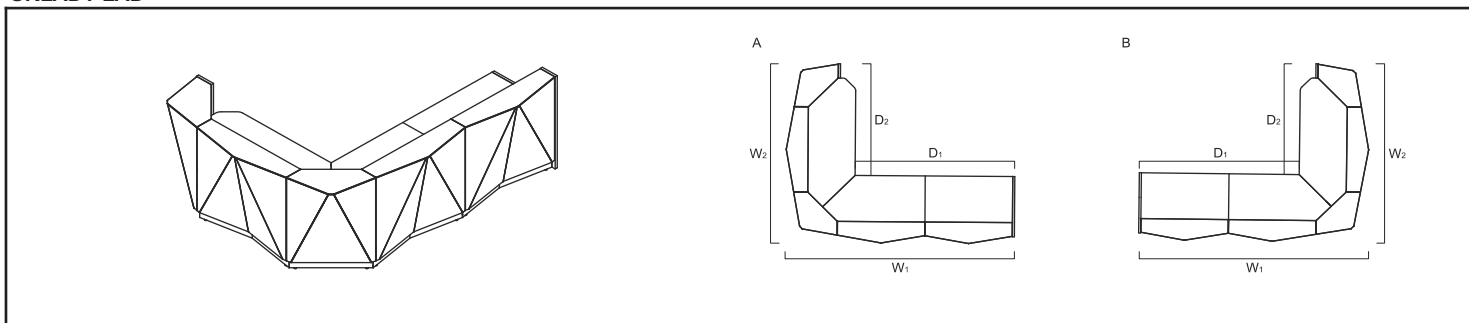

SYMBOL	WYMIARY [mm]						kg	m3	szt	ELEMENTY SKŁADOWE
	W ₁	W ₂	D ₁	D ₂	H					
A ALP17L	3135	2514	2189	1568	1100		238.0	2.757	16	ALP19L+ALP12+ALP1P+NG41
B ALP17P	3135	2514	2189	1568	1100		238.0	2.757	16	ALP1L+ALP12+ALP19P+NG41

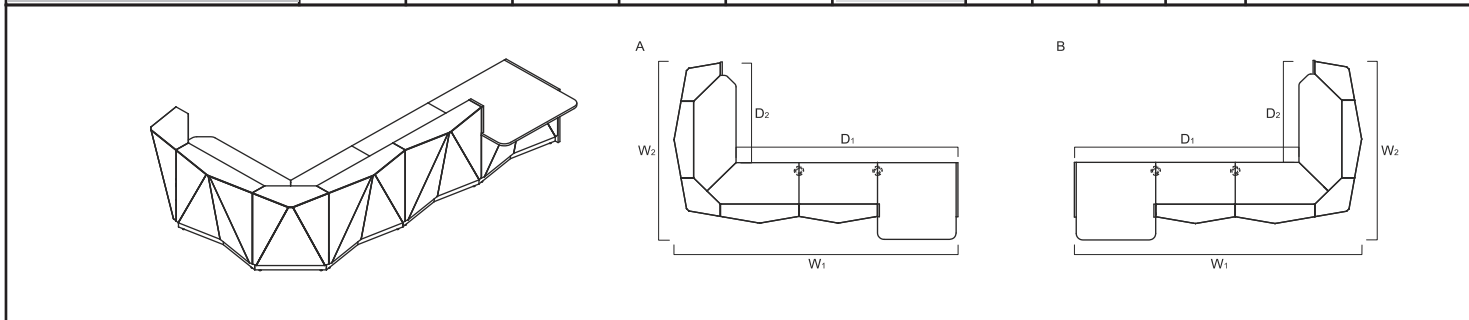

SYMBOL	WYMIARY [mm]						kg	m3	szt	ELEMENTY SKŁADOWE
	W ₁	W ₂	D ₁	D ₂	H					
A ALP26L	4335	2767	3390	1568	1100		298.0	3.243	21	ALP3L+ALP11+ALP2P+ALP12+ALP19P+2xNG41
B ALP26P	4335	2767	3390	1568	1100		298.0	3.243	21	ALP19L+ALP12+ALP2L+ALP11+ALP3P+2xNG41

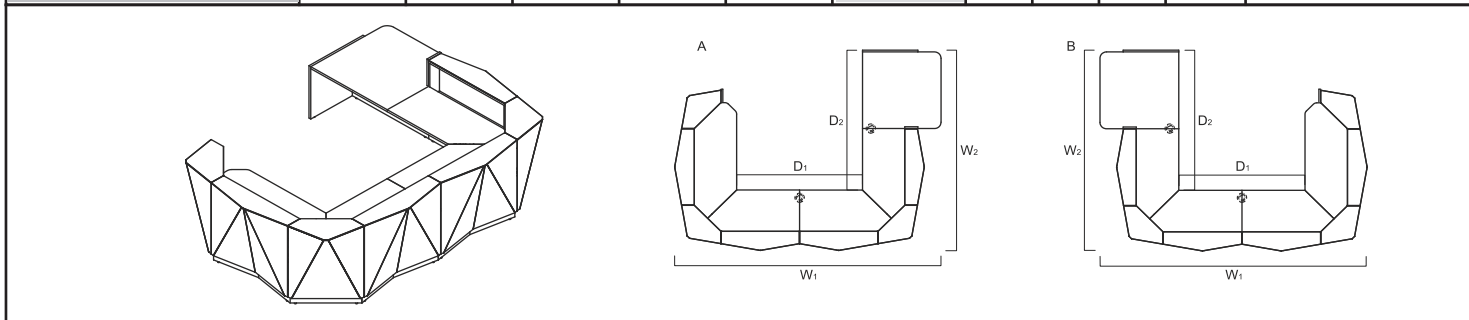



SYMBOL	WYMIARY [mm]						kg	m3	szt	ELEMENTY SKŁADOWE
	W ₁	W ₂	D ₁	D ₂	H					
A ALP27L	3815	3135	1922	2189	1100		382.0	4.237	26	ALP3L+ALP11+ALP2P+ALP90+ALP19P+2xNG41
B ALP27P	3815	3135	1922	2189	1100		382.0	4.237	26	ALP19L+ALP90+ALP2L+ALP11+ALP3P+2xNG41

LEGENDA:

- WAGA NETTO

- OBJĘTOŚĆ

- ILOŚĆ PACZEK

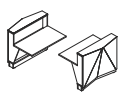
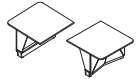
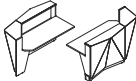
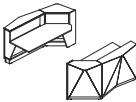
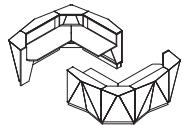
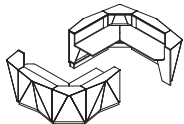
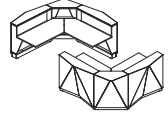
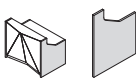
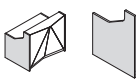
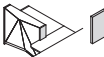
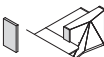

WIDOK I RZUT OBIEKTU	WYMIARY [mm]			SYMBOL						UWAGI
	SZEROKOŚĆ	GŁĘBOKOŚĆ	WYSOKOŚĆ			kg	m3	szt		

ELEMENTY SKŁADOWE



	1200	946	1100	ALP12		50.5	0.714	3		
	1200	1200	740	ALP11		57.5	0.490	3		
	1806	946	1100	ALP18L		90.0	1.013	6		
	1806	946	1100	ALP18P		90.0	1.013	6		
	2514	1907	1100	ALP19L		172.5	2.007	11		
	2514	1907	1100	ALP19P		172.5	2.007	11		
	1907	1907	1100	ALP90		133.5	1.703	6		
	846	28	1100	ALP1L		13.0	0.034	1		bok lady wysokiej - lewy
	846	28	1100	ALP1P		13.0	0.034	1		bok lady wysokiej - prawy
	200	28	368	ALP2L		1.5	0.004	1		bok do łączenia lady niskiej i wysokiej, lewy
	200	28	368	ALP2P		1.5	0.004	1		bok do łączenia lady niskiej i wysokiej, prawy

LEGENDA:

 - WAGA NETTO - OBJĘTOŚĆ - ILOŚĆ PACZEK

WIDOK I RZUT OBIEKTU	WYMIARY [mm]			SYMBOL						UWAGI
	SZEROKOŚĆ	GŁĘBOKOŚĆ	WYSOKOŚĆ			kg	m3	szt		

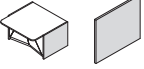
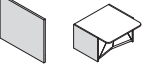
ELEMENTY SKŁADOWE

	846	28	730	ALP3L		12.0	0.024	1		noga do lady niskiej, lewa
	846	28	730	ALP3P		12.0	0.024	1		noga do lady niskiej, prawa
	40	40	712	NG41		2.0	0.002	1		noga kwadratowa

LEGENDA:

 - WAGA NETTO - OBJĘTOŚĆ - ILOŚĆ PACZEK