

## CARACTERÍSTICAS TÉCNICAS

### COLORES

#### ENCIMERA SUPERIOR, ENCIMERA



26 ALUMINIO  
SATINADO



CRISTAL LACOBEL,  
PLATA

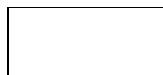

67 BLANCO  
PASTEL

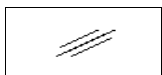

BLANCO, LACOBEL



#### FRONTAL HPL



31 ROBLE  
CANADIENSE



34 CASTAÑO

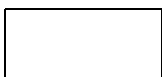

73 BLANCO BRILLO



74 NARANJA  
BRILLO



80 LIMA BRILLO



81 ROJO BURDEOS  
BRILLO



102 AMARILLO  
BRILLO



108 AZUL BRILLO



127 FUCSIA  
BRILLO



148 GRIS



#### INTERIOR



67 BLANCO  
PASTEL



#### PANELES ESTRUCTURALES DE HPL

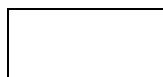

73 BLANCO BRILLO



148 GRIS

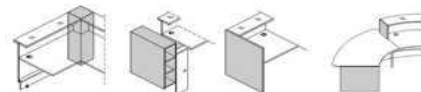

#### FRONTAL LAD10



26 ALUMINIO  
SATINADO



67 BLANCO  
PASTEL

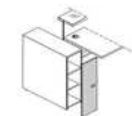

#### PATA DE APOYO EN LA UNIÓN DE ENCIMERAS NL41



M009 ALUMINIO  
SEMI-MATE



M015 BLANCO  
SEMI-MATE



#### ARMARIO PARA MOSTRADORES DE RECEPCIÓN



26 ALUMINIO  
SATINADO

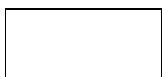

67 BLANCO  
PASTEL



## CARACTERÍSTICAS TÉCNICAS

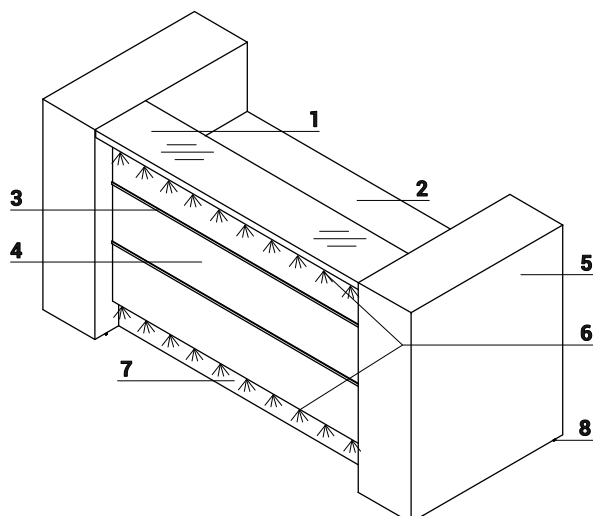

1. **Encimera** - MFC 36mm con cristal LACOBEL 4mm - se pide por separado
2. **Encimera** - MFC 28mm, cantos PVC - con o sin rebajes pasacables
3. **Franja decorativa** - PVC, color M009- aluminio semi-mate
4. **Frontal** - HPL brillo 3mm
5. **Armario como elemento final** - MFC 18mm, cantos PVC
6. Iluminación LED – En toda la longitud del mostrador, color blanco frío (tono azulado)
7. **Kick plate** - HPL - aluminio pulido
8. **Nivelación** - 0-5mm

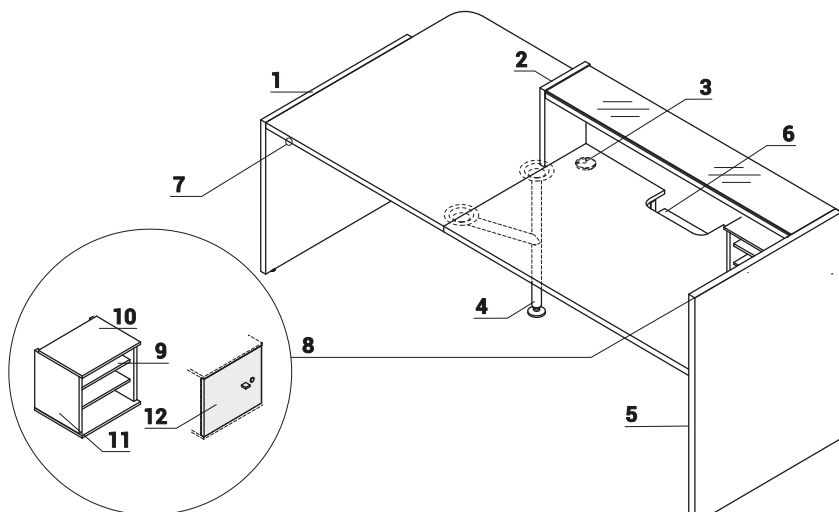

1. **Panel lateral bajo** - HPL brillo - 38mm
2. Panel lateral de unión entre paneles altos y bajos - HPL brillo - 38mm
3. **Tapones pasacables** - Ø80mm
4. **Pata de apoyo NE41** - metálica, requerida para la unión de encimeras. Colores: M015 – blanco semi-mate, M009 – Aluminio semi-mate, color según color de en
5. **Panel lateral alto** - HPL brillo - 38mm
6. **Opción con recargo** - encimera con bandeja inferior para monitor - MFC 28mm, canto PVC
7. Interruptor
8. **LMS05** - armario para mostrador de recepción; se pide por separado
9. **Estante** - MFC 18mm, cantos PVC
10. **Encimera** - MFC 12mm, cantos PVC
11. **Cuerpo** - MFC 18mm, cantos PVC
12. **Opcional: frontal con cerradura** - universal (izda, dcha.) - MFC 18mm, cantos PVC; - se pide por separado

ATENCIÓN - parte interior del frontal en blanco

## ARMARIO FINAL

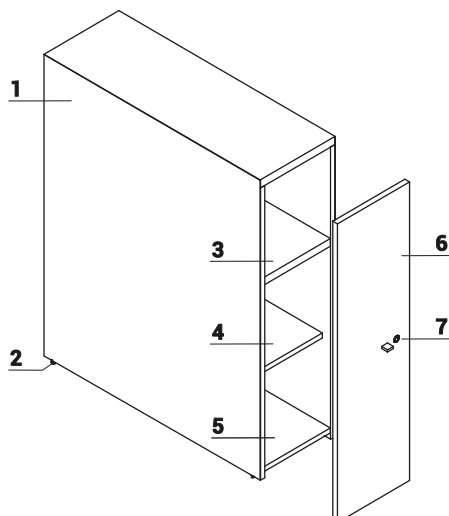

1. **Armario como elemento final** - MFC 18mm, cantos PVC
2. **Nivelación** - 0-5mm
3. **Estante** - MFC 28mm, cantos PVC
4. **Estante con posibilidad de regulación de altura** - MFC 18mm, cantos PVC
5. **Base** - MFC 18mm, cantos PVC
6. Frontal opcional LAD10 – MFC 18mm. Universal (izquierda/derecha), se pide por separado
7. Cierre patentado – llave plegable

**CARACTERÍSTICAS TÉCNICAS**

**APLICACIÓN ELEMENTOS FINALES**

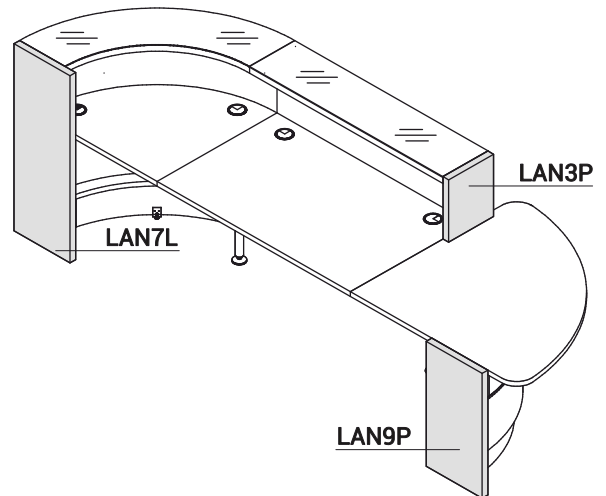
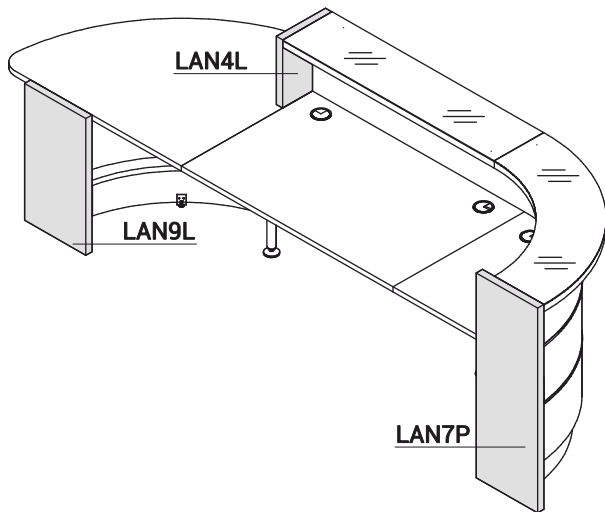
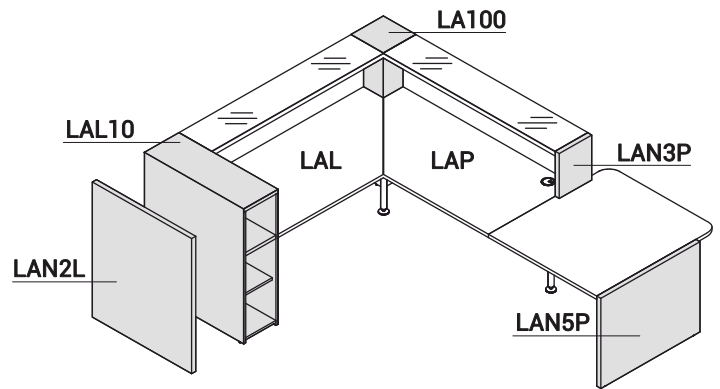
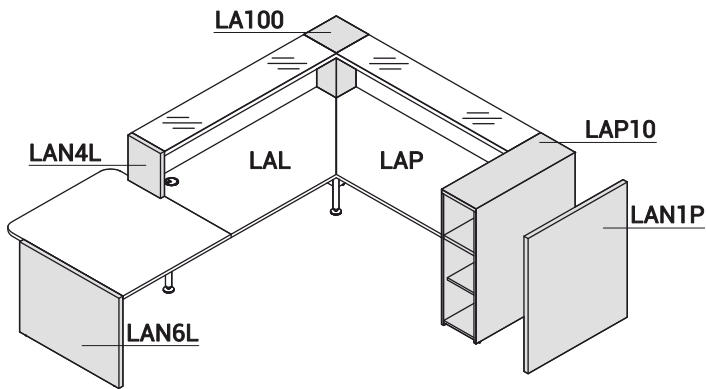

**DIMENSIONES**

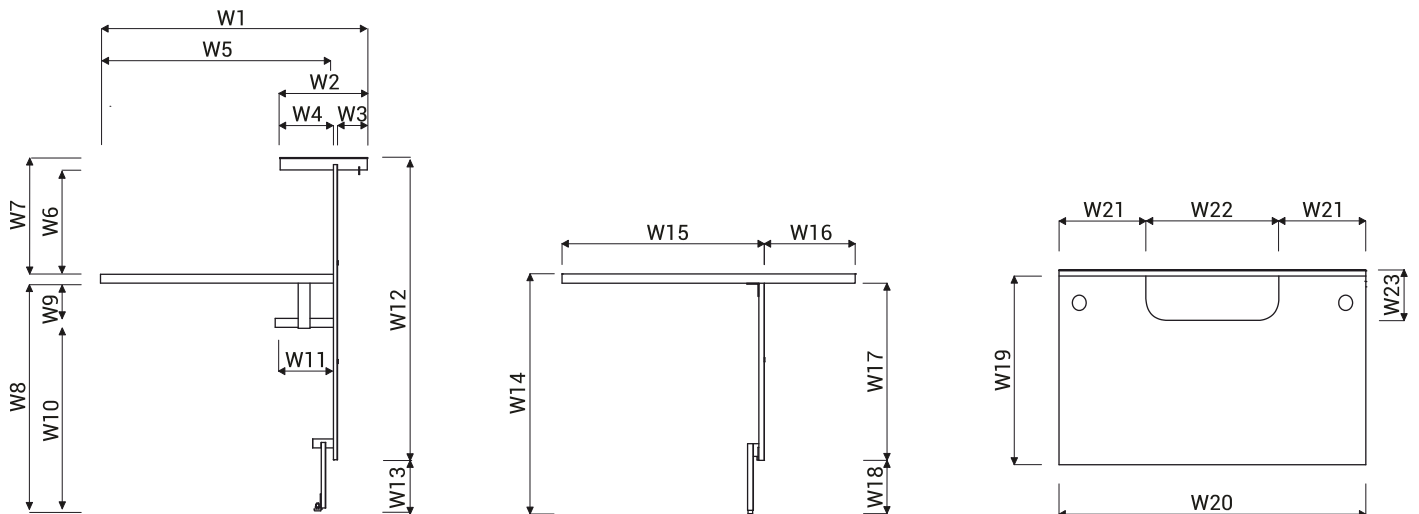

W1 - 916mm | W2 - 300mm | W3 - 103mm | W4 - 183mm | W5 - 800mm | W6 - 324mm | W7 - 364mm | W8 - 712mm | W9 - 110mm | W10 - 574mm | W11 - 200mm | W12 - 944mm | W13 - 150mm | W14 - 740mm | W15 - 814mm | W16 - 300mm | W17 - 580mm | W18 - 160mm | W19 - 800mm | W20 - 1290/1590/2290mm | W21 - 385/535/885mm | W22 - 520mm | W23 - 200mm

## SISTEMAS DE MOSTRADORES DE RECEPCIÓN

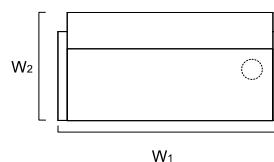
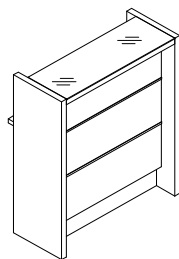

REFERENCIA	DIMENSIONES [mm]										COMPONENTES
	W <sub>1</sub>	W <sub>2</sub>	D <sub>1</sub>	D <sub>2</sub>	H						
LAV96L	920	454			1105		50.5	0.178	5		LAN8L+LA09L+LAN7P

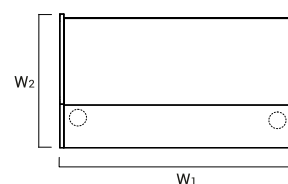
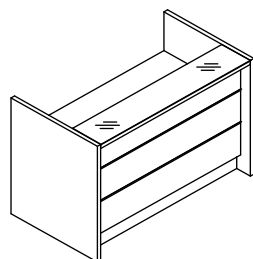

REFERENCIA	DIMENSIONES [mm]										COMPONENTES
	W <sub>1</sub>	W <sub>2</sub>	D <sub>1</sub>	D <sub>2</sub>	H						
LAV95L	920	917			1105		88.0	0.252	6		LAN2L+LA09L+LAN1P
LAV75L	1366	917			1105		105.6	0.326	6		LAN2L+LA13L+LAN1P
LAV76L	1666	917			1105		119.0	0.373	6		LAN2L+LA16L+LAN1P
LAV77L	2366	917			1105		145.5	0.497	7		LAN2L+LA23L+LAN1P

## RECARGO ADICIONAL

CARACTERÍSTICA	PRODUCTO												COMENTARIOS	
			LAV75L	LAV76L	LAV77L									
BANDEJA PARA MONITOR X 1											0.1	0.0001	1	

DESCRIPCIÓN:

- PESO NETO

- VOLUMEN

- NÚMERO DE PAQUETES

## SISTEMAS DE MOSTRADORES DE RECEPCIÓN

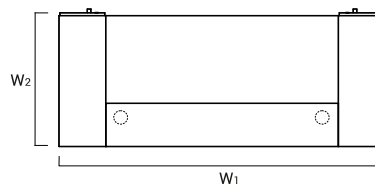
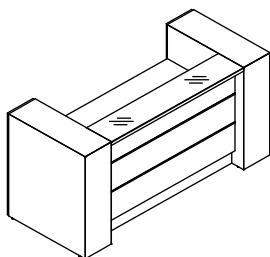

REFERENCIA	DIMENSIONES [mm]						kg	m3	pcs	COMONENTES
	W <sub>1</sub>	W <sub>2</sub>	D <sub>1</sub>	D <sub>2</sub>	H					
LAV01L	1926	937			1105		162.6	0.973	8	LAD10+LAL10+LA13L+LAP10+LAD10
LAV02L	2226	937			1105		176.0	1.020	8	LAD10+LAL10+LA16L+LAP10+LAD10
LAV03L	2926	937			1105		202.5	1.145	9	LAD10+LAL10+LA23L+LAP10+LAD10

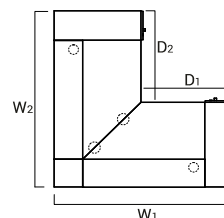
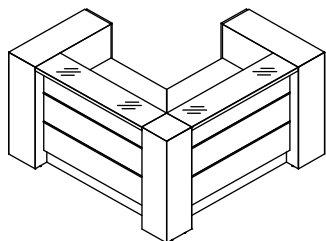

REFERENCIA	DIMENSIONES [mm]						kg	m3	pcs	COMONENTES
	W <sub>1</sub>	W <sub>2</sub>	D <sub>1</sub>	D <sub>2</sub>	H					
LAV10L	1908	1908	991	991	1105		238.4	1.374	14	LAD10+LAL10+LAL13L+LA100+LAP13L+LAP10+LAD10+NL41
LAV11L	1908	2208	991	1291	1105		252.3	1.421	14	LAD10+LAL10+LAL13L+LA100+LAP16L+LAP10+LAD10+NL41
LAV12L	1908	2908	991	1991	1105		278.8	1.546	15	LAD10+LAL10+LAL13L+LA100+LAP23L+LAP10+LAD10+NL41
LAV13L	2208	1908	1291	991	1105		252.3	1.421	14	LAD10+LAL10+LAL16L+LA100+LAP13L+LAP10+LAD10+NL41
LAV14L	2208	2208	1291	1291	1105		266.2	1.468	14	LAD10+LAL10+LAL16L+LA100+LAP16L+LAP10+LAD10+NL41
LAV15L	2208	2908	1291	1991	1105		292.7	1.593	15	LAD10+LAL10+LAL16L+LA100+LAP23L+LAP10+LAD10+NL41

## RECARGO ADICIONAL

CARACTERÍSTICA	PRODUCTO									kg	m3	pcs	COMENTARIOS
	LAV01L	LAV02L	LAV03L	LAV10L	LAV11L	LAV12L	LAV13L	LAV14L	LAV15L				
BANDEJA PARA MONITOR X 1										0.1	0.0001	1	
BANDEJA PARA MONITOR X 2										0.9	0.0070	1	

DESCRIPCIÓN:

- PESO NETO

- VOLUMEN

- NÚMERO DE PAQUETES

## SISTEMAS DE MOSTRADORES DE RECEPCIÓN

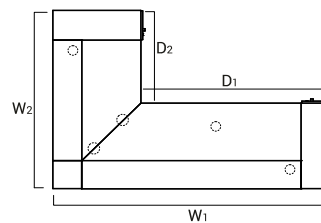
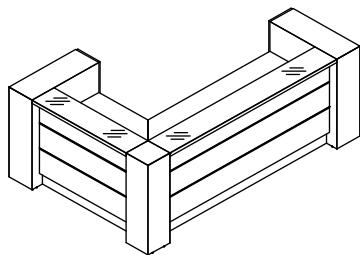

REFERENCIA	DIMENSIONES [mm]										COMPONENTES
	W <sub>1</sub>	W <sub>2</sub>	D <sub>1</sub>	D <sub>2</sub>	H						
LAV16L	2908	1908	1991	991	1105		278.8	1.546	15		LAD10+LAL10+LAL23L+LA100 +LAP13L+LAP10+LAD10+NL41
LAV17L	2908	2208	1991	1291	1105		292.7	1.593	15		LAD10+LAL10+LAL23L+LA100 +LAP16L+LAP10+LAD10+NL41
LAV18L	2908	2908	1991	1991	1105		319.2	1.717	16		LAD10+LAL10+LAL23L+LA100 +LAP23L+LAP10+LAD10+NL41

## RECARGO ADICIONAL

CARACTERÍSTICA	PRODUCTO													COMENTARIOS
	LAV16L	LAV17L	LAV18L											
BANDEJA PARA MONITOR X 1											0.1	0.0001	1	
BANDEJA PARA MONITOR X 2											0.9	0.0070	1	

DESCRIPCIÓN:

- PESO NETO

- VOLUMEN

- NÚMERO DE PAQUETES

## SISTEMAS DE MOSTRADORES DE RECEPCIÓN

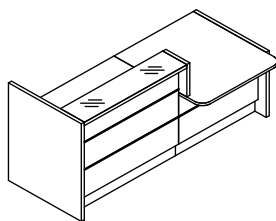

A

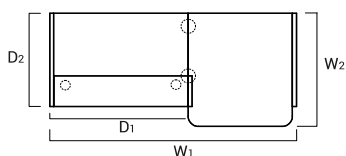

B

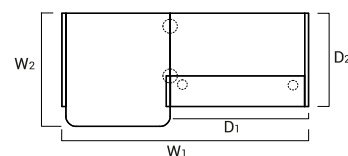

REFERENCIA	DIMENSIONES [mm]										COMPONENTES
	W <sub>1</sub>	W <sub>2</sub>	D <sub>1</sub>	D <sub>2</sub>	H						
A LAV19L	2366	1114	1328	917	1105		138.9	0.509	12		LAN6L+LAU111L+LAN4L+LA13L+LAN1P+NL41
B LAV20L	2366	1114	1328	917	1105		138.9	0.509	12		LAN1P+LA13L+LAN3P+LAU111L+LAN5P+NL41
A LAV21L	2666	1114	1628	917	1105		152.3	0.556	12		LAN6L+LAU111L+LAN4L+LA16L+LAN1P+NL41
B LAV22L	2666	1104	1628	917	1105		152.3	0.556	12		LAN1P+LA16L+LAN3P+LAU111L+LAN5P+NL41
A LAV23L	3366	1114	2318	917	1105		178.8	0.680	13		LAN6L+LAU111L+LAN4L+LA23L+LAN1P+NL41
B LAV24L	3366	1114	2318	917	1105		178.8	0.680	13		LAN1P+LA23L+LAN3P+LAU111L+LAN5P+NL41
A LAV191L	2166	1114	1328	917	1105		134.9	0.486	12		LAN6L+LAU111L+LAN4L+LA13L+LAN1P+NL41
B LAV201L	2366	1114	1328	917	1105		134.9	0.486	12		LAN1P+LA13L+LAN3P+LAU111L+LAN5P+NL41
A LAV211L	2466	1114	1628	917	1105		148.3	0.533	12		LAN6L+LAU111L+LAN4L+LA16L+LAN1P+NL41
B LAV221L	2466	1104	1628	917	1105		148.3	0.533	12		LAN1P+LA16L+LAN3P+LAU111L+LAN5P+NL41
A LAV231L	3166	1114	2318	917	1105		174.8	0.657	13		LAN6L+LAU111L+LAN4L+LA23L+LAN1P+NL41
B LAV241L	3166	1114	2318	917	1105		174.8	0.657	13		LAN1P+LA23L+LAN3P+LAU111L+LAN5P+NL41

## RECARGO ADICIONAL

CARACTERÍSTICA	PRODUCTO															COMENTARIOS
	LAV19L	LAV20L	LAV21L	LAV22L	LAV23L	LAV24L	LAV191L	LAV201L	LAV211L	LAV221L	LAV231L	LAV241L				
BANDEJA PARA MONITOR X 1													0.1	0.0001	1	

DESCRIPCIÓN:

- PESO NETO

- VOLUMEN

- NÚMERO DE PAQUETES

## SISTEMAS DE MOSTRADORES DE RECEPCIÓN

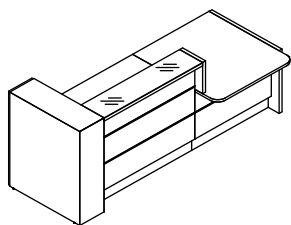

A

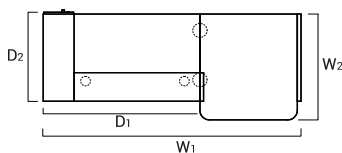

B

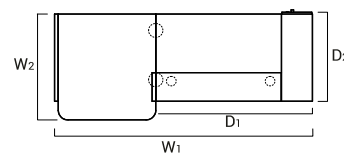

REFERENCIA	DIMENSIONES [mm]										COMPONENTES
	W <sub>1</sub>	W <sub>2</sub>	D <sub>1</sub>	D <sub>2</sub>	H						
A LAV41L	2646	1134	1608	937	1105		167.4	0.833	13		LAN6L+LAU111L+LAN4L+LA13L +LAP10+LAD10+NL41
B LAV42L	2646	1134	1608	937	1105		167.4	0.833	13		LAD10+LAL10+LA13L+LAN3P +LAU111L+LAN5P+NL41
A LAV43L	2946	1134	1908	937	1105		180.8	0.880	13		LAN6L+LAU111L+LAN4L+LA16L +LAP10+LAD10+NL41
B LAV44L	2946	1134	1908	937	1105		180.8	0.880	13		LAD10+LAL10+LA16L+LAN3P +LAU111L+LAN5P+NL41
A LAV45L	3646	1134	2608	937	1105		207.3	1.004	14		LAN6L+LAU111L+LAN4L+LA23L +LAP10+LAD10+NL41
B LAV46L	3646	1134	2608	937	1105		207.3	1.004	14		LAD10+LAL10+LA23L+LAN3P +LAU111L+LAN5P+NL41
A LAV411L	2446	1134	1608	937	1105		163.4	0.809	13		LAN6L+LAU111L+LAN4L+LA13L +LAP10+LAD10+NL41
B LAV421L	2446	1134	1608	937	1105		163.4	0.809	13		LAD10+LAL10+LA13L+LAN3P +LAU111L+LAN5P+NL41
A LAV431L	2746	1134	1908	937	1105		176.8	0.856	13		LAN6L+LAU111L+LAN4L+LA16L +LAP10+LAD10+NL41
B LAV441L	2746	1134	1908	937	1105		176.8	0.856	13		LAD10+LAL10+LA16L+LAN3P +LAU111L+LAN5P+NL41
A LAV451L	3446	1134	2608	937	1105		203.3	0.981	14		LAN6L+LAU111L+LAN4L+LA23L +LAP10+LAD10+NL41
B LAV461L	3446	1134	2608	937	1105		203.3	0.981	14		LAD10+LAL10+LA23L+LAN3P +LAU111L+LAN5P+NL41

## RECARGO ADICIONAL

CARACTERÍSTICA	PRODUCTO															COMENTARIOS	
	LAV41L	LAV42L	LAV43L	LAV44L	LAV45L	LAV46L	LAV411L	LAV421L	LAV431L	LAV441L	LAV451L	LAV461L					
BANDEJA PARA MONITOR X 1														0.1	0.0001	1	

DESCRIPCIÓN:

- PESO NETO

- VOLUMEN

- NÚMERO DE PAQUETES



SISTEMAS DE MOSTRADORES DE RECEPCIÓN

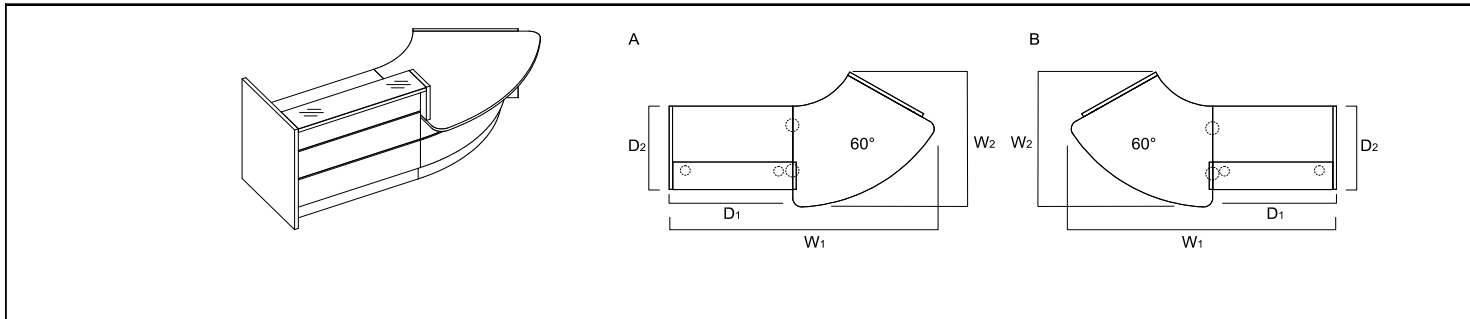

REFERENCIA	DIMENSIONES [mm]						kg	m3	pcs	COMONENTES
	W <sub>1</sub>	W <sub>2</sub>	D <sub>1</sub>	D <sub>2</sub>	H					
A LAV88L	2845	1486	1328	917	1105		160.9	0.832	12	LAN6L+LAV66L+LAN4L+LA13L+LAN1P+NL41
B LAV89L	2845	1486	1328	917	1105		160.9	0.832	12	LAN2L+LA13L+LAN3P+LAV66L+LAN5P+NL41
A LAV91L	3145	1486	1628	917	1105		174.3	0.879	12	LAN6L+LAV66L+LAN4L+LA16L+LAN1P+NL41
B LAV92L	3145	1486	1628	917	1105		174.3	0.879	12	LAN2L+LA16L+LAN3P+LAV66L+LAN5P+NL41

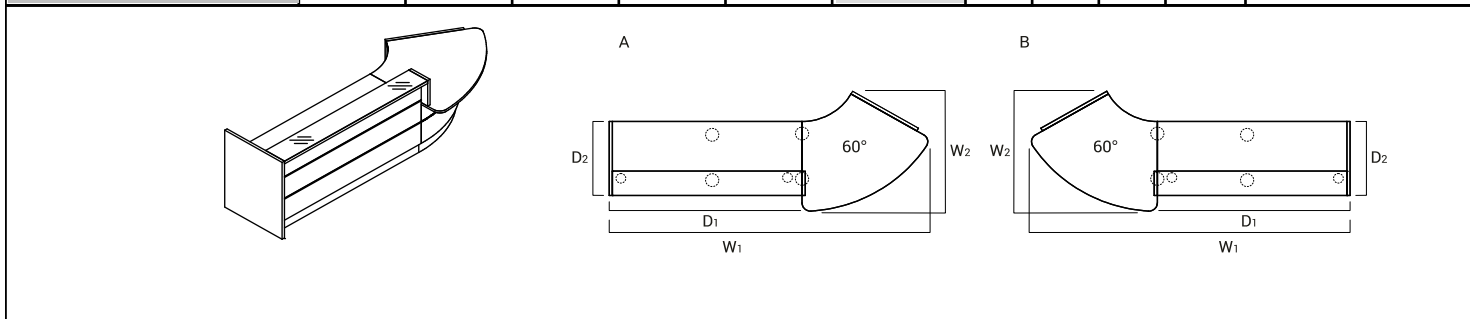

REFERENCIA	DIMENSIONES [mm]						kg	m3	pcs	COMONENTES
	W <sub>1</sub>	W <sub>2</sub>	D <sub>1</sub>	D <sub>2</sub>	H					
A LAV93L	3845	1486	2318	917	1105		200.8	1.003	13	LAN6L+LAV66L+LAN4L+LA23L+LAN1P+NL41
B LAV94L	3845	1486	2318	917	1105		200.8	1.003	13	LAN2L+LA23L+LAN3P+LAV66L+LAN5P+NL41

RECARGO ADICIONAL

CARACTERÍSTICA	PRODUCTO							kg	m3	pcs	COMENTARIOS
	LAV88L	LAV89L	LAV91L	LAV92L	LAV93L	LAV94L					
BANDEJA PARA MONITOR X 1								0.1	0.0001	1	

DESCRIPCIÓN:

- PESO NETO

- VOLUMEN

- NÚMERO DE PAQUETES

## SISTEMAS DE MOSTRADORES DE RECEPCIÓN

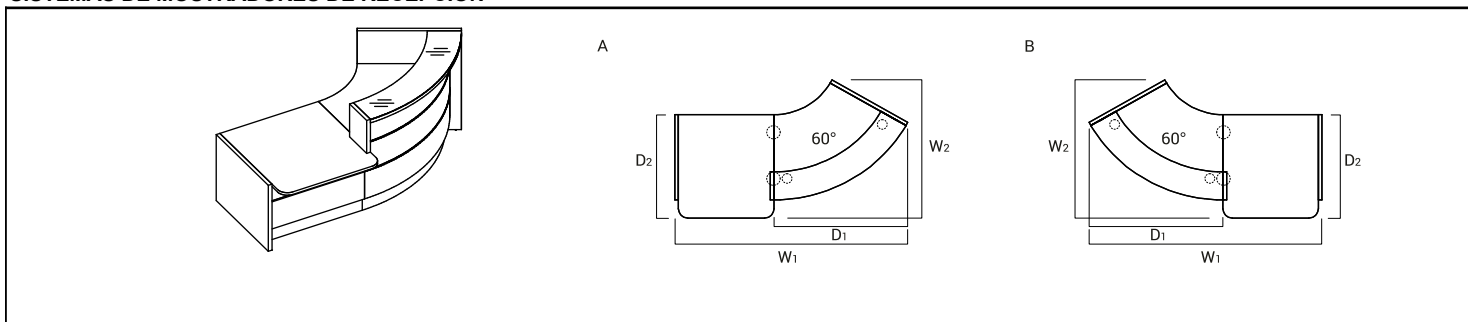

REFERENCIA	DIMENSIONES [mm]						kg	m3	pcs	COMONENTES
	W <sub>1</sub>	W <sub>2</sub>	D <sub>1</sub>	D <sub>2</sub>	H					
A <b>LAV84L</b>	2443	1489	1404	1114	1105		149.8	0.957	12	LAN2L+LAV64L+LAN3P+LAU11L+LAN5P+NL41
B <b>LAV85L</b>	2443	1489	1404	1114	1105		149.8	0.957	12	LAN6L+LAU11L+LAN4L+LAV64L+LAN1P+NL41
A <b>LAV841L</b>	2243	1489	1404	1114	1105		145.8	0.934	12	LAN2L+LAV64L+LAN3P+LAU111L+LAN5P+NL41
B <b>LAV851L</b>	2243	1489	1404	1114	1105		145.8	0.934	12	LAN6L+LAU111L+LAN4L+LAV64L+LAN1P+NL41

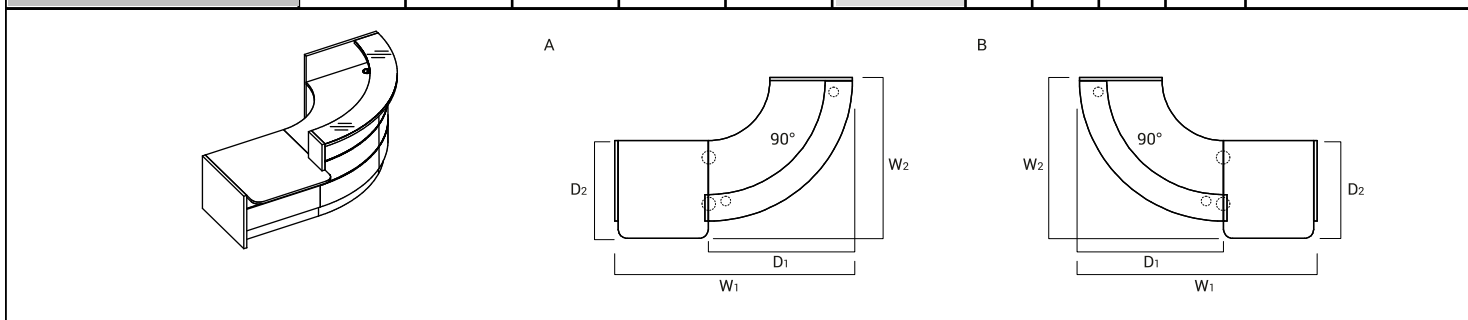

REFERENCIA	DIMENSIONES [mm]						kg	m3	pcs	COMONENTES
	W <sub>1</sub>	W <sub>2</sub>	D <sub>1</sub>	D <sub>2</sub>	H					
A <b>LAV86L</b>	2638	1835	1600	937	1105		190.8	1.328	13	LAN2L+LAV90L+LAN3P+LAU11L+LAN5P+NL41
B <b>LAV87L</b>	2638	1835	1600	937	1105		190.8	1.328	13	LAN6L+LAU11L+LAN4L+LAV90L+LAN1P+NL41
A <b>LAV861L</b>	2438	1835	1600	937	1105		186.8	1.305	13	LAN2L+LAV90L+LAN3P+LAU111L+LAN5P+NL41
B <b>LAV871L</b>	2438	1835	1600	937	1105		186.8	1.305	13	LAN6L+LAU111L+LAN4L+LAV90L+LAN1P+NL41

## RECARGO ADICIONAL

CARACTERÍSTICA	PRODUCTO								kg	m3	pcs	COMENTARIOS
	LAV84L	LAV85L	LAV841L	LAV851L	LAV86L	LAV87L	LAV861L	LAV871L				
BANDEJA PARA MONITOR X 1									0.1	0.0001	1	

DESCRIPCIÓN:

- PESO NETO

- VOLUMEN

- NÚMERO DE PAQUETES

SISTEMAS DE MOSTRADORES DE RECEPCIÓN

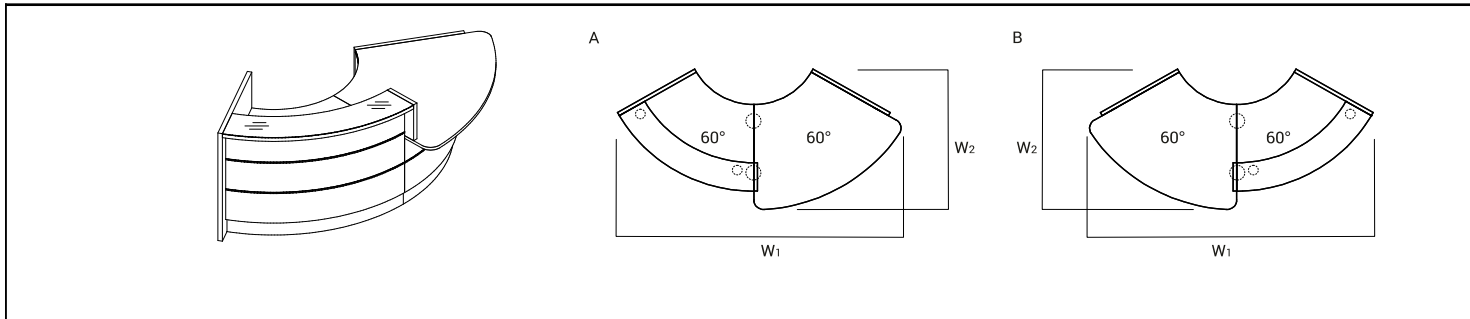

REFERENCIA	DIMENSIONES [mm]										COMPONENTES
	W <sub>1</sub>	W <sub>2</sub>	D <sub>1</sub>	D <sub>2</sub>	H						
A <b>LAV30L</b>	2922	1486			1105		171.8	1.280	12		LAN6L+LAV66L+LAN4L+LAV64L+LAN1P+NL41
B <b>LAV31L</b>	2922	1486			1105		171.8	1.280	12		LAN2L+LAV64L+LAN3P+LAV66L+LAN5P+NL41

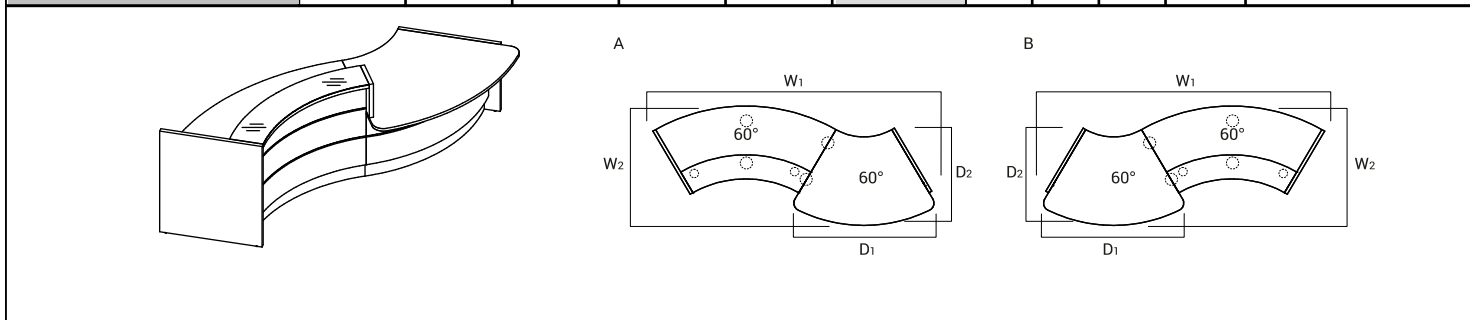

REFERENCIA	DIMENSIONES [mm]										COMPONENTES
	W <sub>1</sub>	W <sub>2</sub>	D <sub>1</sub>	D <sub>2</sub>	H						
A <b>LAV32L</b>	3452	1502	1720	1225	1105		182.8	1.366	13		LAN6L+LAV66L+LAN4L+LAV62L+LAN1P+NL41
B <b>LAV33L</b>	3452	1502			1105		182.8	1.366	13		LAN2L+LAV62L+LAN3P+LAV66L+LAN5P+NL41

RECARGO ADICIONAL

CARACTERÍSTICA	PRODUCTO													COMENTARIOS
	LAV30L	LAV31L	LAV32L	LAV33L										
BANDEJA PARA MONITOR X 1											0.1	0.0001	1	

DESCRIPCIÓN:

- PESO NETO

- VOLUMEN

- NÚMERO DE PAQUETES

SISTEMAS DE MOSTRADORES DE RECEPCIÓN

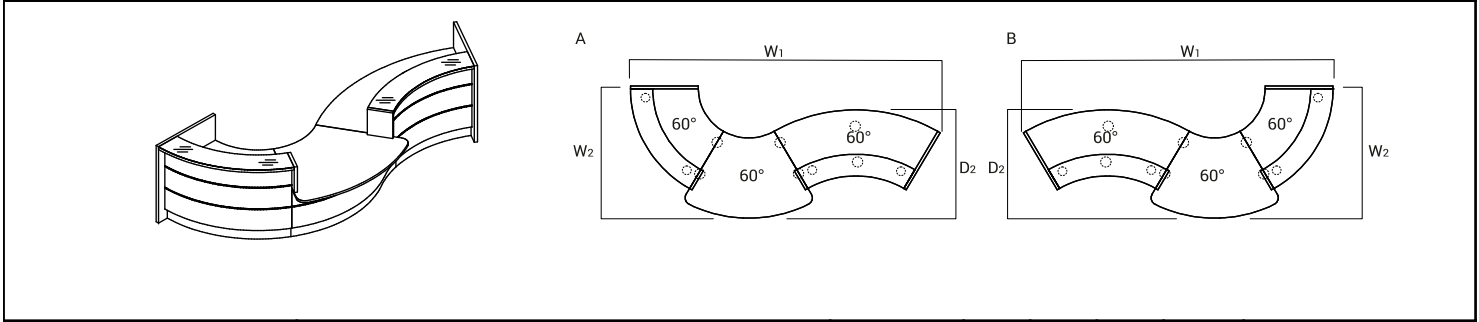

REFERENCIA	DIMENSIONES [mm]						kg	m3	pcs	COMONENTES
	W <sub>1</sub>	W <sub>2</sub>	D <sub>1</sub>	D <sub>2</sub>	H					
A <b>LAV34L</b>	4195	1835	-	1503	1105		262.1	2.129	20	LAN2L+LAV62L+LAN3P+LAV66L +LAN4L+LAV64L+LAN1P+2xNL41
B <b>LAV35L</b>	4195	1835			1105		262.1	2.129	20	LAN2L+LAV64L+LAN3P+LAV66L +LAN4L+LAV62L+LAN1P+2xNL41

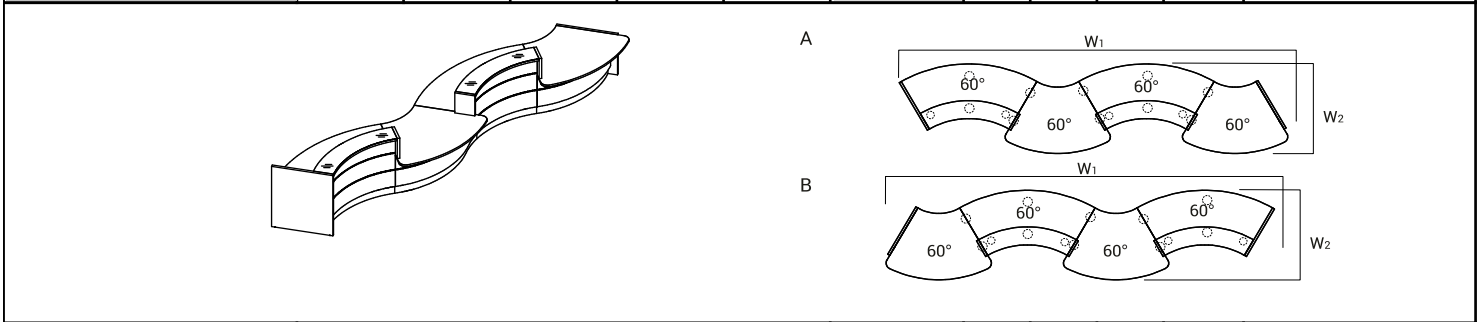

REFERENCIA	DIMENSIONES [mm]						kg	m3	pcs	COMONENTES
	W <sub>1</sub>	W <sub>2</sub>	D <sub>1</sub>	D <sub>2</sub>	H					
A <b>LAV36L</b>	6352	1503			1105		325.4	2.715	26	LAN6L+2xLAV66L+2xLAN4L +2xLAV62L+LAN3P+LAN1P +3xNL41
B <b>LAV37L</b>	6352	1503			1105		325.4	2.715	26	LAN2L+2xLAV62L+2xLAN3P +2xLAV66L+LAN4L+LAN5P +3xNL41

RECARGO ADICIONAL

CARACTERÍSTICA	PRODUCTO									kg	m3	pcs	COMENTARIOS
	LAV34L	LAV35L	LAV36L	LAV37L									
BANDEJA PARA MONITOR X 1										0.1	0.0001	1	
BANDEJA PARA MONITOR X 2										0.9	0.0070	1	

DESCRIPCIÓN:

- PESO NETO

- VOLUMEN

- NÚMERO DE PAQUETES

SISTEMAS DE MOSTRADORES DE RECEPCIÓN

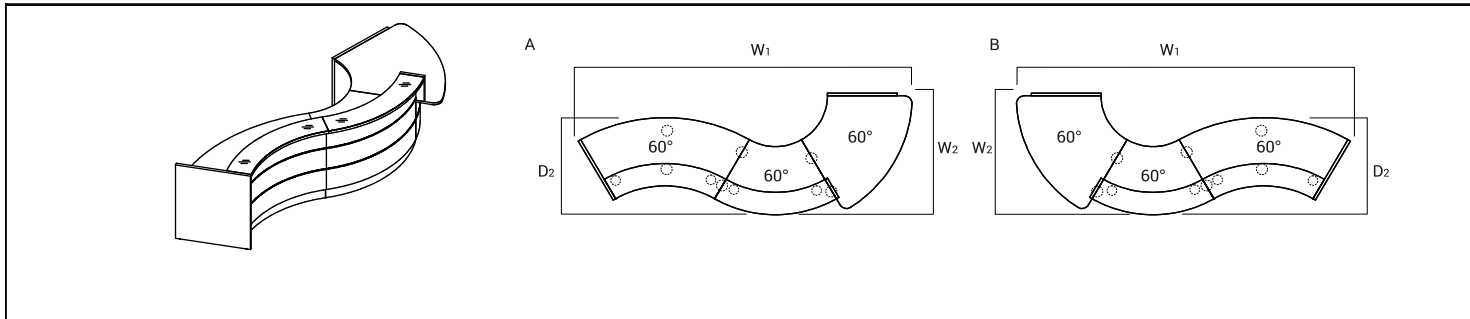

REFERENCIA	DIMENSIONES [mm]					kg	m3	pcs	COMPONENTES
	W <sub>1</sub>	W <sub>2</sub>	D <sub>1</sub>	D <sub>2</sub>	H				
A <b>LAV38L</b>	4386	1639	-	1307	1105	252.3	2.106	19	LAN6L+LAV66L+LAN4L+LAV64L+LAV62L+LAN1P+2xNL41
B <b>LAV39L</b>	4386	1639	-	1307	1105	252.3	2.106	19	LAN2L+LAV62L+LAV64L+LAN3P+LAV66L+LAN5P+2xNL41

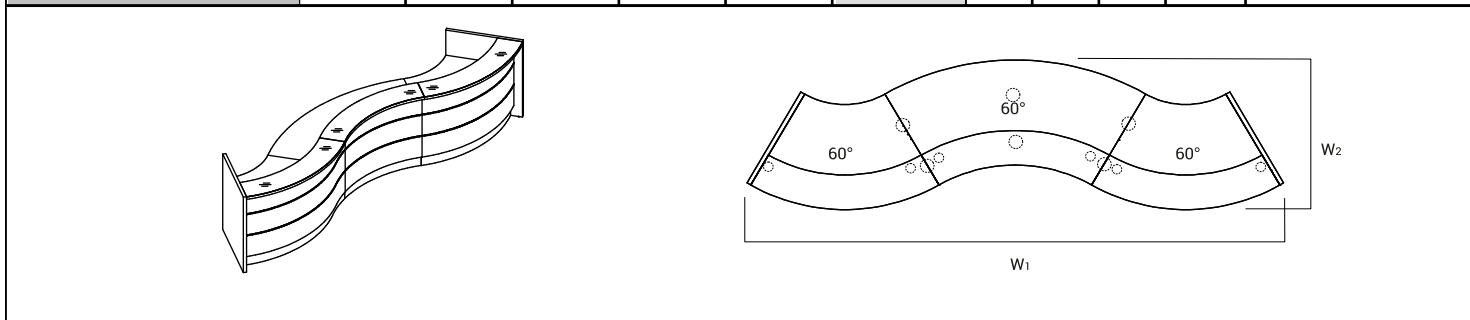

REFERENCIA	DIMENSIONES [mm]					kg	m3	pcs	COMPONENTES
	W <sub>1</sub>	W <sub>2</sub>	D <sub>1</sub>	D <sub>2</sub>	H				
<b>LAV50L</b>	4566	1307			1105	260.5	2.329	17	LAN2L+2xLAV64L+LAV62L+LAN1P+2xNL41

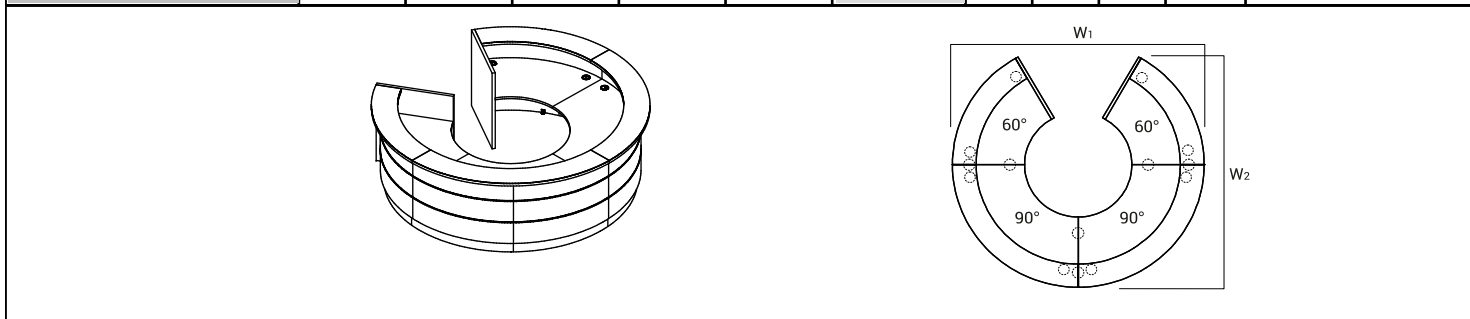

REFERENCIA	DIMENSIONES [mm]					kg	m3	pcs	COMPONENTES
	W <sub>1</sub>	W <sub>2</sub>	D <sub>1</sub>	D <sub>2</sub>	H				
<b>LAV51L</b>	3202	3006			1105	410.0	3.741	27	LAN2L+2xLAV64L+2xLAV90L+LAN1P+3xNL41

RECARGO ADICIONAL

CARACTERÍSTICA	PRODUCTO								kg	m3	pcs	COMENTARIOS
	LAV38L	LAV39L	LAV50L	LAV51L								
BANDEJA PARA MONITOR X 1									0.1	0.0001	1	
BANDEJA PARA MONITOR X 2									0.9	0.0070	1	
BANDEJA PARA MONITOR X 3									0.9	0.0070	1	
BANDEJA PARA MONITOR X 4									0.0	0.0000	0	

DESCRIPCIÓN:

- PESO NETO

- VOLUMEN

- NÚMERO DE PAQUETES

## SISTEMAS DE MOSTRADORES DE RECEPCIÓN

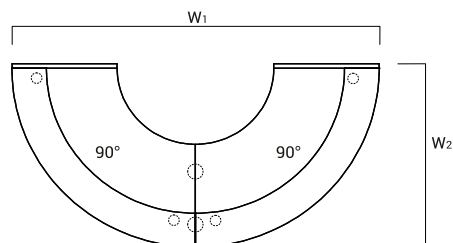
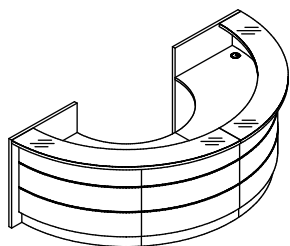

REFERENCIA	DIMENSIONES [mm]						kg	m3	pcs	COMPONENTES
	W <sub>1</sub>	W <sub>2</sub>	D <sub>1</sub>	D <sub>2</sub>	H					
LAV52L	3202	1639			1105		271.0	2.261	15	LAN2L+2xLAV90L+LAN1P+NL41

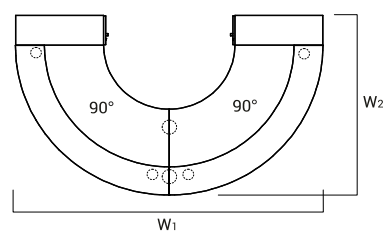
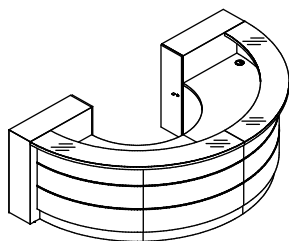

REFERENCIA	DIMENSIONES [mm]						kg	m3	pcs	COMPONENTES
	W <sub>1</sub>	W <sub>2</sub>	D <sub>1</sub>	D <sub>2</sub>	H					
LAV61L	3202	1919			1105		322.0	2.898	15	LAD10+LAL10+2xLAV90L+LAP10+LAD10+NL41

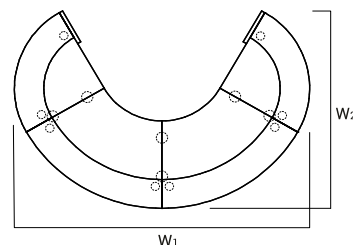
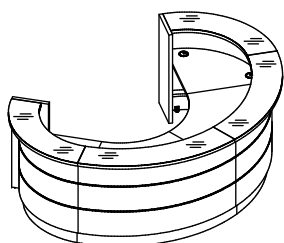

REFERENCIA	DIMENSIONES [mm]						kg	m3	pcs	COMPONENTES
	W <sub>1</sub>	W <sub>2</sub>	D <sub>1</sub>	D <sub>2</sub>	H					
LAV04L	3202	3006			1105		250.0	2.312	23	LAN8L+2xLAV70L+2xLAV64L+LAN7P+3xNL41

## RECARGO ADICIONAL

CARACTERÍSTICA	PRODUCTO								kg	m3	pcs	COMENTARIOS
	LAV52L	LAV61L	LAV04L									
BANDEJA PARA MONITOR X 1									0.1	0.0001	1	
BANDEJA PARA MONITOR X 2									0.9	0.0070	1	

DESCRIPCIÓN:

- PESO NETO

- VOLUMEN

- NÚMERO DE PAQUETES

SISTEMAS DE MOSTRADORES DE RECEPCIÓN

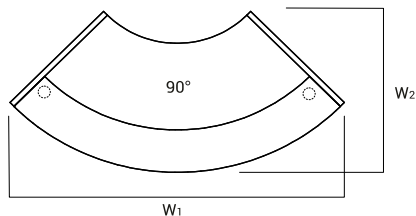
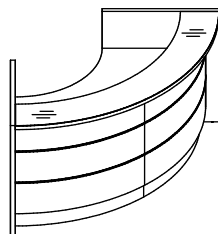

REFERENCIA	DIMENSIONES [mm]										COMPONENTES
	W <sub>1</sub>	W <sub>2</sub>	D <sub>1</sub>	D <sub>2</sub>	H						
LAV53L	2317	1145			1105		160.5	1.150	8		LAN2L+LAV90L+LAN1P

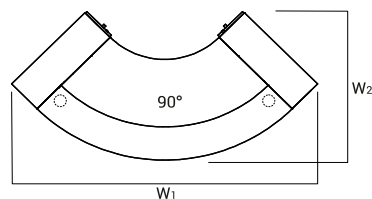
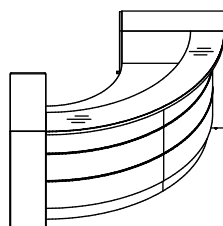

REFERENCIA	DIMENSIONES [mm]										COMPONENTES
	W <sub>1</sub>	W <sub>2</sub>	D <sub>1</sub>	D <sub>2</sub>	H						
LAV73L	2713	1353			1105		217.5	1.798	10		LAD10+LAL10+LAV90L+LAP10+LAD10

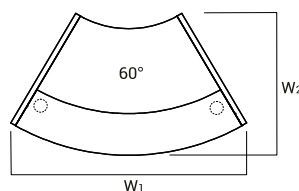
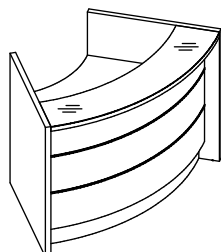

REFERENCIA	DIMENSIONES [mm]										COMPONENTES
	W <sub>1</sub>	W <sub>2</sub>	D <sub>1</sub>	D <sub>2</sub>	H						
LAV54L	1666	1029			1105		119.5	0.779	7		LAN2L+LAV64L+LAN1P

RECARGO ADICIONAL

CARACTERÍSTICA	PRODUCTO												COMENTARIOS	
	LAV53L	LAV73L	LAV54L											
BANDEJA PARA MONITOR X 1											0.1	0.0001	1	

DESCRIPCIÓN:

- PESO NETO

- VOLUMEN

- NÚMERO DE PAQUETES

## SISTEMAS DE MOSTRADORES DE RECEPCIÓN

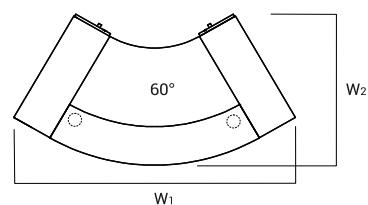
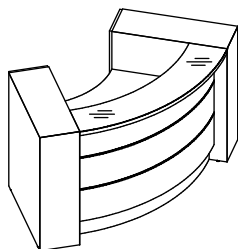

REFERENCIA	DIMENSIONES [mm]						kg	m3	pcs	COMPLEMENTOS
	W <sub>1</sub>	W <sub>2</sub>	D <sub>1</sub>	D <sub>2</sub>	H					
LAV74L	2151	1183			1105		176.5	1.427	9	LAD10+LAL10+LAV64L+LAP10+LAD10

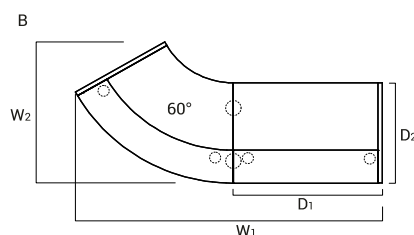
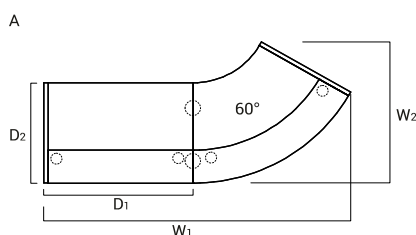
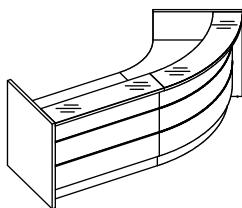

REFERENCIA	DIMENSIONES [mm]						kg	m3	pcs	COMPLEMENTOS
	W <sub>1</sub>	W <sub>2</sub>	D <sub>1</sub>	D <sub>2</sub>	H					
A LAV78L	2733	1292	1328	917	1105		178.1	1.071	13	LAN2L+LAV64L+LA13L+LAN1P+NL41
B LAV79L	2733	1292	1328	917	1105		178.1	1.071	13	LAN2L+LA13L+LAV64L+LAN1P+NL41
A LAV80L	3033	1292	1628	917	1105		191.5	1.118	13	LAN2L+LAV64L+LA16L+LAN1P+NL41
B LAV81L	3033	1292	1628	917	1105		191.5	1.118	13	LAN2L+LA16L+LAV64L+LAN1P+NL41
A LAV82L	3733	1292	2318	917	1105		218.0	1.242	14	LAN2L+LAV64L+LA23L+LAN1P+NL41
B LAV83L	3733	1292	2318	917	1105		218.0	1.242	14	LAN2L+LA23L+LAV64L+LAN1P+NL41

## RECARGO ADICIONAL

CARACTERÍSTICA	PRODUCTO								kg	m3	pcs	COMENTARIOS
	LAV74L	LAV78L	LAV79L	LAV80L	LAV81L	LAV82L	LAV83L					
BANDEJA PARA MONITOR X 1									0.1	0.0001	1	
BANDEJA PARA MONITOR X 2									0.9	0.0070	1	

DESCRIPCIÓN:

- PESO NETO

- VOLUMEN

- NÚMERO DE PAQUETES



## SISTEMAS DE MOSTRADORES DE RECEPCIÓN

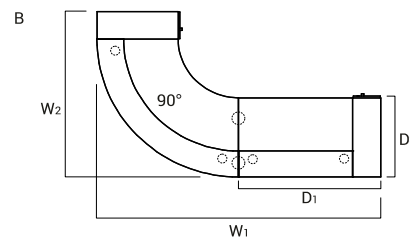
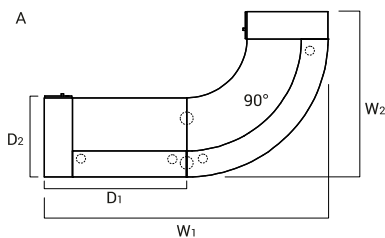
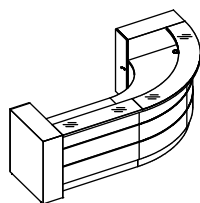

REFERENCIA	DIMENSIONES [mm]						⚖️	📦	📦		COMPONENTES
	W <sub>1</sub>	W <sub>2</sub>	D <sub>1</sub>	D <sub>2</sub>	H						
A <b>LAV55L</b>	3208	1918	1608	937	1105		276.1	2.089	16		LAD10+LAL10+LAV90L+LA13L +LAP10+LAD10+NL41
B <b>LAV56L</b>	3208	1918	1608	937	1105		276.1	2.089	16		LAD10+LAL10+LA13L+LAV90L +LAP10+LAD10+NL41
A <b>LAV57L</b>	3508	1918	1908	937	1105		289.5	2.137	16		LAD10+LAL10+LAV90L+LA16L +LAP10+LAD10+NL41
B <b>LAV58L</b>	3508	1918	1908	937	1105		289.5	2.137	16		LAD10+LAL10+LA16L+LAV90L +LAP10+LAD10+NL41

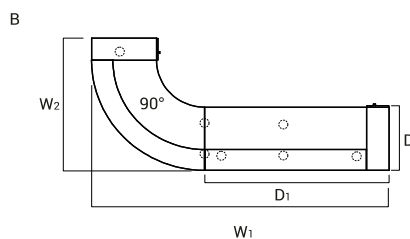
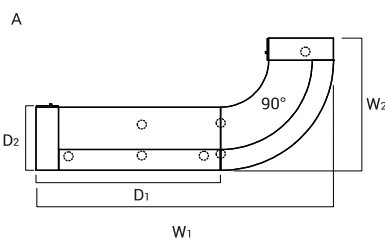
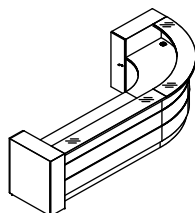

REFERENCIA	DIMENSIONES [mm]						⚖️	📦	📦		COMPONENTES
	W <sub>1</sub>	W <sub>2</sub>	D <sub>1</sub>	D <sub>2</sub>	H						
A <b>LAV59L</b>	4208	1918	2608	937	1105		316.0	2.261	17		LAD10+LAL10+LAV90L+LA23L +LAP10+LAD10+NL41
B <b>LAV60L</b>	4208	1918	2608	937	1105		316.0	2.261	17		LAD10+LAL10+LA23L+LAV90L +LAP10+LAD10+NL41

## RECARGO ADICIONAL

CARACTERÍSTICA	PRODUCTO						⚖️	📦	📦	COMENTARIOS
	LAV55L	LAV56L	LAV57L	LAV58L	LAV59L	LAV60L				
BANDEJA PARA MONITOR X 1							0.1	0.0001	1	
BANDEJA PARA MONITOR X 2							0.9	0.0070	1	

DESCRIPCIÓN:

⚖️ - PESO NETO

📦 - VOLUMEN

📦 - NÚMERO DE PAQUETES

## SISTEMAS DE MOSTRADORES DE RECEPCIÓN

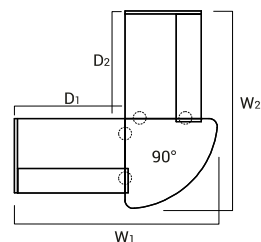
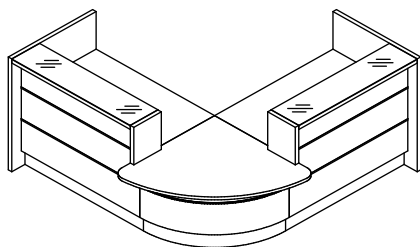

REFERENCIA	DIMENSIONES [mm]						kg	m3	pcs	COMONENTES
	W <sub>1</sub>	W <sub>2</sub>	D <sub>1</sub>	D <sub>2</sub>	H					
LAV101L	2437	2437	1328	1328	1105		204.3	0.950	17	LAN2L+LA13L+LAN3P+LAV68L +LAN4L+LA13L+LAN1P+2xNL41
LAV102L	2437	2737	1328	1628	1105		217.7	0.997	17	LAN2L+LA16L+LAN3P+LAV68L +LAN4L+LA13L+LAN1P+2xNL41
LAV103L	2437	3437	1328	2318	1105		244.2	1.121	18	LAN2L+LA23L+LAN3P+LAV68L +LAN4L+LA13L+LAN1P+2xNL41
LAV104L	2737	2437	1628	1328	1105		217.7	0.997	17	LAN2L+LA13L+LAN3P+LAV68L +LAN4L+LA16L+LAN1P+2xNL41
LAV105L	2737	2737	1628	1628	1105		231.1	1.044	17	LAN2L+LA16L+LAN3P+LAV68L +LAN4L+LA16L+LAN1P+2xNL41
LAV106L	2737	3437	1628	2318	1105		257.6	1.168	18	LAN2L+LA23L+LAN3P+LAV68L +LAN4L+LA16L+LAN1P+2xNL41

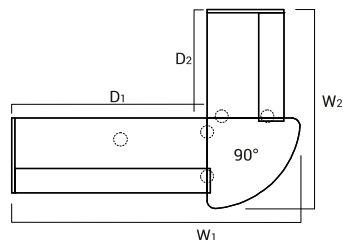
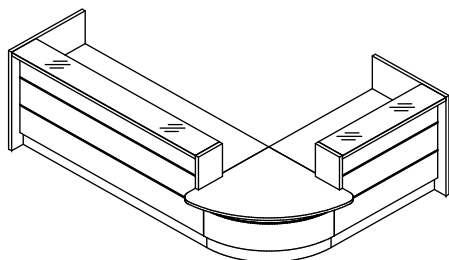

REFERENCIA	DIMENSIONES [mm]						kg	m3	pcs	COMONENTES
	W <sub>1</sub>	W <sub>2</sub>	D <sub>1</sub>	D <sub>2</sub>	H					
LAV107L	3437	2437	2318	1328	1105		244.2	1.121	18	LAN2L+LA13L+LAN3P+LAV68L +LAN4L+LA23L+LAN1P+2xNL41
LAV108L	3437	2737	2318	1628	1105		257.6	1.168	18	LAN2L+LA16L+LAN3P+LAV68L +LAN4L+LA23L+LAN1P+2xNL41
LAV109L	3437	3437	2318	2318	1105		284.1	1.293	19	LAN2L+LA23L+LAN3P+LAV68L +LAN4L+LA23L+LAN1P+2xNL41

## RECARGO ADICIONAL

CARACTERÍSTICA	PRODUCTO									kg	m3	pcs	COMENTARIOS
	LAV101L	LAV102L	LAV103L	LAV104L	LAV105L	LAV106L	LAV107L	LAV108L	LAV109L				
BANDEJA PARA MONITOR X 1										0.1	0.0001	1	
BANDEJA PARA MONITOR X 2										0.9	0.0070	1	

DESCRIPCIÓN:

- PESO NETO

- VOLUMEN

- NÚMERO DE PAQUETES

## SISTEMAS DE MOSTRADORES DE RECEPCIÓN

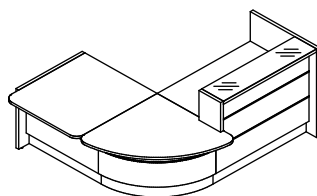

A

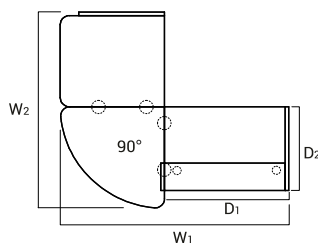

B

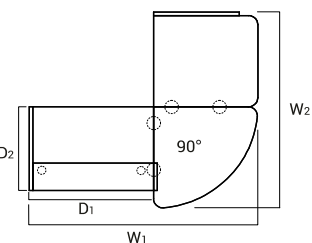

REFERENCIA	DIMENSIONES [mm]										COMPONENTES
	W <sub>1</sub>	W <sub>2</sub>	D <sub>1</sub>	D <sub>2</sub>	H						
A LAV110L	2442	2147	1328	917	1105		176.4	0.832	16		LAN2L+LA13L+LAN3P+LAV68L+LAU11L+LAN5P+2xNL41
B LAV111L	2442	2147	1328	917	1105		176.4	0.832	16		LAN6L+LAN11L+LAV68L+LAN4L+LA13L+LAN1P+2xNL41
A LAV112L	2742	2147	1628	917	1105		189.8	0.879	16		LAN2L+LA16L+LAN3P+LAV68L+LAU11L+LAN5P+2xNL41
B LAV113L	2742	2147	1628	917	1105		189.8	0.879	16		LAN6L+LAN11L+LAV68L+LAN4L+LA16L+LAN1P+2xNL41
A LAV114L	3442	2147	2318	917	1105		216.3	1.004	17		LAN2L+LA23L+LAN3P+LAV68L+LAU11L+LAN5P+2xNL41
B LAV115L	3442	2147	2318	917	1105		216.3	1.004	17		LAN6L+LAN11L+LAV68L+LAN4L+LA23L+LAN1P+2xNL41
A LAV1101L	2442	1947	1328	917	1105		172.4	0.809	16		LAN2L+LA13L+LAN3P+LAV68L+LAU11L+LAN5P+2xNL41
B LAV1111L	2442	1947	1328	917	1105		172.4	0.809	16		LAN6L+LAN11L+LAV68L+LAN4L+LA13L+LAN1P+2xNL41
A LAV1121L	2742	1947	1628	917	1105		185.8	0.856	16		LAN2L+LA16L+LAN3P+LAV68L+LAU11L+LAN5P+2xNL41
B LAV1131L	2742	1947	1628	917	1105		185.8	0.856	16		LAN6L+LAN11L+LAV68L+LAN4L+LA16L+LAN1P+2xNL41
A LAV1141L	3442	1947	2318	917	1105		212.3	0.980	17		LAN2L+LA23L+LAN3P+LAV68L+LAU11L+LAN5P+2xNL41
B LAV1151L	3442	1947	2318	917	1105		212.3	0.980	17		LAN6L+LAN11L+LAV68L+LAN4L+LA23L+LAN1P+2xNL41

## RECARGO ADICIONAL

CARACTERÍSTICA	PRODUCTO															COMENTARIOS	
	LAV110L	LAV111L	LAV112L	LAV113L	LAV114L	LAV115L	LAV1101L	LAV1111L	LAV1121L	LAV1131L	LAV1141L	LAV1151L					
BANDEJA PARA MONITOR X 1														0.1	0.0001	1	

DESCRIPCIÓN:

- PESO NETO

- VOLUMEN

- NÚMERO DE PAQUETES

## SISTEMAS DE MOSTRADORES DE RECEPCIÓN

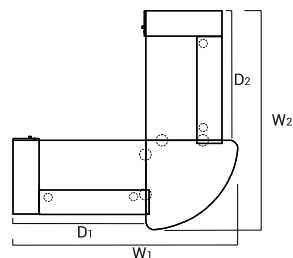
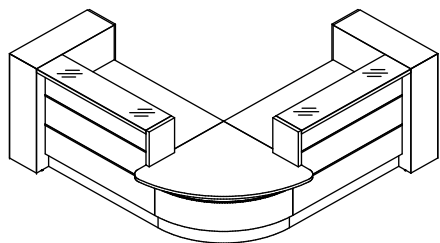

REFERENCIA	DIMENSIONES [mm]						kg	m3	pcs	COMONENTES
	W <sub>1</sub>	W <sub>2</sub>	D <sub>1</sub>	D <sub>2</sub>	H					
LAV116L	2717	2717	1608	1608	1105		261.3	1.597	19	LAD10+LAL10+LA13L+LAN3P +LAV68L+LAN4L+LA13L+LAP10 +LAD10+2xNL41
LAV117L	2717	3017	1608	1908	1105		274.7	1.644	19	LAD10+LAL10+LA16L+LAN3P +LAV68L+LAN4L+LA13L+LAP10 +LAD10+2xNL41
LAV118L	2717	3717	1608	2608	1105		301.2	1.769	20	LAD10+LAL10+LA23L+LAN3P +LAV68L+LAN4L+LA13L+LAP10 +LAD10+2xNL41
LAV119L	3017	2717	1908	1608	1105		274.7	1.644	19	LAD10+LAL10+LA13L+LAN3P +LAV68L+LAN4L+LA16L+LAP10 +LAD10+2xNL41
LAV120L	3017	3017	1908	1908	1105		288.1	1.691	19	LAD10+LAL10+LA16L+LAN3P +LAV68L+LAN4L+LA16L+LAP10 +LAD10+2xNL41
LAV121L	3017	3717	1908	2608	1105		314.6	1.816	20	LAD10+LAL10+LA23L+LAN3P +LAV68L+LAN4L+LA16L+LAP10 +LAD10+2xNL41

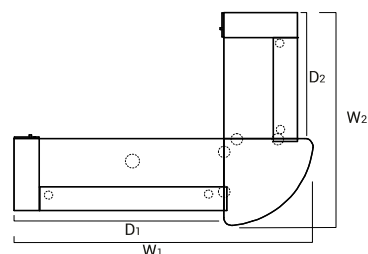
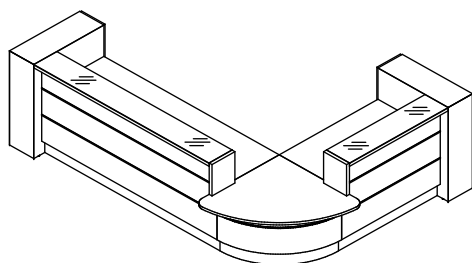

REFERENCIA	DIMENSIONES [mm]						kg	m3	pcs	COMONENTES
	W <sub>1</sub>	W <sub>2</sub>	D <sub>1</sub>	D <sub>2</sub>	H					
LAV122L	3717	2717	2608	1608	1105		301.2	1.769	20	LAD10+LAL10+LA13L+LAN3P +LAV68L+LAN4L+LA23L+LAP10 +LAD10+2xNL41
LAV123L	3717	3017	2608	1908	1105		314.6	1.816	20	LAD10+LAL10+LA16L+LAN3P +LAV68L+LAN4L+LA23L+LAP10 +LAD10+2xNL41
LAV124L	3717	3717	2608	2608	1105		341.1	1.940	21	LAD10+LAL10+LA23L+LAN3P +LAV68L+LAN4L+LA23L+LAP10 +LAD10+2xNL41

## RECARGO ADICIONAL

CARACTERÍSTICA	PRODUCTO									kg	m3	pcs	COMENTARIOS
	LAV116L	LAV117L	LAV118L	LAV119L	LAV120L	LAV121L	LAV122L	LAV123L	LAV124L				
BANDEJA PARA MONITOR X 1										0.1	0.0001	1	
BANDEJA PARA MONITOR X 2										0.9	0.0070	1	

DESCRIPCIÓN:

- PESO NETO

- VOLUMEN

- NÚMERO DE PAQUETES

## SISTEMAS DE MOSTRADORES DE RECEPCIÓN

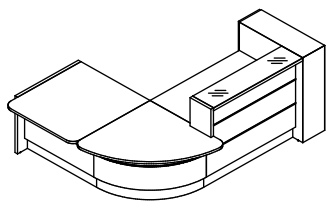

A

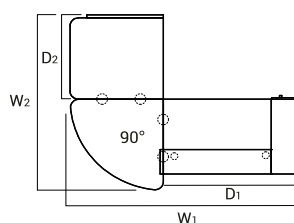

B

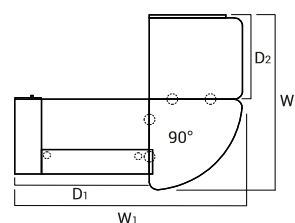

REFERENCIA	DIMENSIONES [mm]						kg	m3	pcs	COMPLEMENTOS
	W <sub>1</sub>	W <sub>2</sub>	D <sub>1</sub>	D <sub>2</sub>	H					
A LAV125L	2722	2147	1608	1038	1105		206.4	1.162	17	LAD10+LAL10+LA13L+LAN3P +LAV68L+LAU11L+LAN5P+2xNL41
B LAV126L	2722	2147	1608	1038	1105		201.9	1.151	16	LAN6L+LAU11L+LAV68L+LAN4L +LA13L+LAP10+LAD10+2xNL41
A LAV127L	3022	2147	1908	1038	1105		215.3	1.198	16	LAD10+LAL10+LA16L+LAN3P +LAV68L+LAU11L+LAN5P+2xNL41
B LAV128L	3022	2147	1908	1038	1105		215.3	1.198	16	LAN6L+LAU11L+LAV68L+LAN4L +LA16L+LAP10+LAD10+2xNL41
A LAV129L	3722	2147	2608	1038	1105		241.8	1.322	17	LAD10+LAL10+LA23L+LAN3P +LAV68L+LAU11L+LAN5P+2xNL41
B LAV130L	3722	2147	2608	1038	1105		241.8	1.322	17	LAN6L+LAU11L+LAV68L+LAN4L +LA23L+LAP10+LAD10+2xNL41
A LAV1251L	2722	1947	1608	838	1105		202.4	1.138	17	LAD10+LAL10+LA13L+LAN3P +LAV68L+LAU11L+LAN5P +2xNL41
B LAV1261L	2722	1947	1608	838	1105		197.9	1.128	16	LAN6L+LAU11L+LAV68L+LAN4L +LA13L+LAP10+LAD10+2xNL41
A LAV1271L	3022	1947	1908	838	1105		211.3	1.175	16	LAD10+LAL10+LA16L+LAN3P +LAV68L+LAU11L+LAN5P +2xNL41
B LAV1281L	3022	1947	1908	838	1105		211.3	1.175	16	LAN6L+LAU11L+LAV68L+LAN4L +LA16L+LAP10+LAD10+2xNL41
A LAV1291L	3722	1947	2608	838	1105		237.8	1.299	17	LAD10+LAL10+LA23L+LAN3P +LAV68L+LAU11L+LAN5P +2xNL41
B LAV1301L	3722	1947	2608	838	1105		237.8	1.299	17	LAN6L+LAU11L+LAV68L+LAN4L +LA23L+LAP10+LAD10+2xNL41

## RECARGO ADICIONAL

CARACTERÍSTICA	PRODUCTO												kg	m3	pcs	COMENTARIOS	
	LAV125L	LAV126L	LAV127L	LAV128L	LAV129L	LAV130L	LAV1251L	LAV1261L	LAV1271L	LAV1281L	LAV1291L	LAV1301L					
BANDEJA PARA MONITOR X 1														0.1	0.0001	1	

DESCRIPCIÓN:

- PESO NETO

- VOLUMEN

- NÚMERO DE PAQUETES

## SISTEMAS DE MOSTRADORES DE RECEPCIÓN

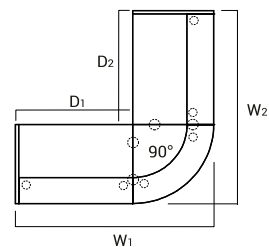
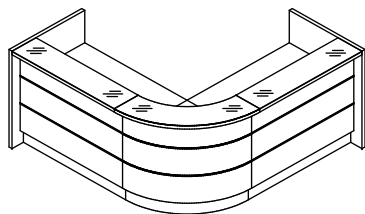

REFERENCIA	DIMENSIONES [mm]						kg	m3	pcs		COMPONENTES
	W <sub>1</sub>	W <sub>2</sub>	D <sub>1</sub>	D <sub>2</sub>	H						
LAV131L	2245	2245	1328	1328	1105		206.7	1.036	16		LAN2L+LA13L+LAV70L+LA13L +LAN1P+2xNL41
LAV132L	2245	2545	1328	1628	1105		220.1	1.083	16		LAN2L+LA16L+LAV70L+LA13L +LAN1P+2xNL41
LAV133L	2245	3245	1328	2318	1105		246.6	1.208	17		LAN2L+LA23L+LAV70L+LA13L +LAN1P+2xNL41

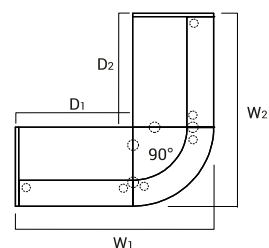
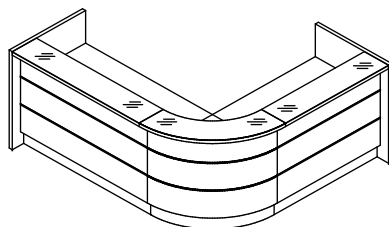

REFERENCIA	DIMENSIONES [mm]						kg	m3	pcs		COMPONENTES
	W <sub>1</sub>	W <sub>2</sub>	D <sub>1</sub>	D <sub>2</sub>	H						
LAV134L	2545	2245	1628	1328	1105		220.1	1.083	16		LAN2L+LA13L+LAV70L+LA16L +LAN1P+2xNL41
LAV135L	2545	2545	1628	1628	1105		233.5	1.130	16		LAN2L+LA16L+LAV70L+LA16L +LAN1P+2xNL41
LAV136L	2545	3245	1628	2318	1105		260.0	1.255	17		LAN2L+LA23L+LAV70L+LA16L +LAN1P+2xNL41

## RECARGO ADICIONAL

CARACTERÍSTICA	PRODUCTO							kg	m3	pcs	COMENTARIOS
	LAV131L	LAV132L	LAV133L	LAV134L	LAV135L	LAV136L					
BANDEJA PARA MONITOR X 1								0.1	0.0001	1	
BANDEJA PARA MONITOR X 2								0.9	0.0070	1	

DESCRIPCIÓN:

- PESO NETO

- VOLUMEN

- NÚMERO DE PAQUETES

SISTEMAS DE MOSTRADORES DE RECEPCIÓN

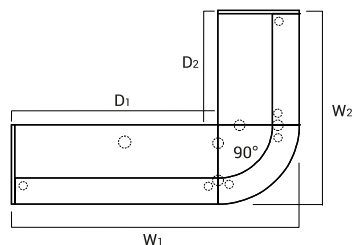
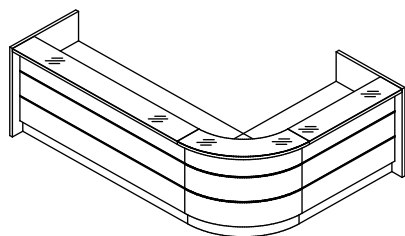

REFERENCIA	DIMENSIONES [mm]						kg	m3	pcs	COMPLEMENTOS
	W <sub>1</sub>	W <sub>2</sub>	D <sub>1</sub>	D <sub>2</sub>	H					
LAV137L	3245	2245	2318	1328	1105		246.6	1.208	17	LAN2L+LA13L+LAV70L+LA23L+LAN1P+2xNL41
LAV138L	3245	2545	2318	1628	1105		260.0	1.255	17	LAN2L+LA16L+LAV70L+LA23L+LAN1P+2xNL41
LAV139L	3245	3245	2318	2318	1105		286.5	1.379	18	LAN2L+LA23L+LAV70L+LA23L+LAN1P+2xNL41

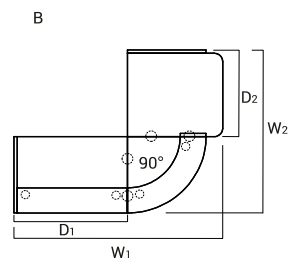
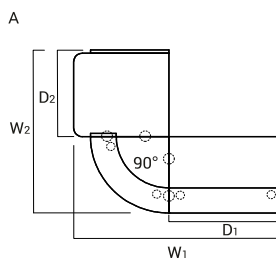
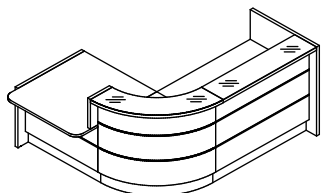

REFERENCIA	DIMENSIONES [mm]						kg	m3	pcs	COMPLEMENTOS
	W <sub>1</sub>	W <sub>2</sub>	D <sub>1</sub>	D <sub>2</sub>	H					
A LAV140L	2442	1955	1328	1038	1105		184.4	0.933	17	LAN2L+LA13L+LAV70L+LAN3P+LAU11L+LAN5P+2xNL41
B LAV141L	2442	1955	1328	1038	1105		184.4	0.933	17	LAN6L+LAU11L+LAN4L+LAV70L+LA13L+LAN1P+2xNL41
A LAV142L	2742	1955	1628	1038	1105		197.8	0.980	17	LAN2L+LA16L+LAV70L+LAN3P+LAU11L+LAN5P+2xNL41
B LAV143L	2742	1955	1628	1038	1105		197.8	0.980	17	LAN6L+LAU11L+LAN4L+LAV70L+LA16L+LAN1P+2xNL41
A LAV1401L	2442	1755	1328	838	1105		180.4	0.910	17	LAN2L+LA13L+LAV70L+LAN3P+LAU11L+LAN5P+2xNL41
B LAV1411L	2442	1755	1328	838	1105		180.4	0.910	17	LAN6L+LAU11L+LAN4L+LAV70L+LA13L+LAN1P+2xNL41
A LAV1421L	2742	1755	1628	838	1105		193.8	0.957	17	LAN2L+LA16L+LAV70L+LAN3P+LAU11L+LAN5P+2xNL41
B LAV1431L	2742	1755	1628	838	1105		193.8	0.957	17	LAN6L+LAU11L+LAN4L+LAV70L+LA16L+LAN1P+2xNL41

RECARGO ADICIONAL

CARACTERÍSTICA	PRODUCTO											kg	m3	pcs	COMENTARIOS
	LAV137L	LAV138L	LAV139L	LAV140L	LAV141L	LAV142L	LAV143L	LAV1401L	LAV1411L	LAV1421L	LAV1431L				
BANDEJA PARA MONITOR X 1												0.1	0.0001	1	

DESCRIPCIÓN:

- PESO NETO

- VOLUMEN

- NÚMERO DE PAQUETES

SISTEMAS DE MOSTRADORES DE RECEPCIÓN

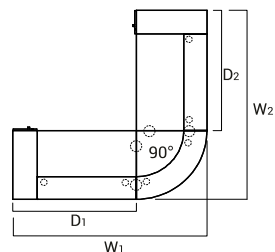
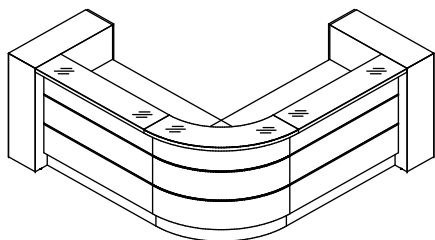

REFERENCIA	DIMENSIONES [mm]						kg	m3	pcs		COMPONENTES
	W <sub>1</sub>	W <sub>2</sub>	D <sub>1</sub>	D <sub>2</sub>	H						
LAV146L	2525	2525	1608	1608	1105		263.7	1.684	18		LAD10+LAL10+LA13L+LAV70L +LA13L+LAP10+LAD10+2xNL41
LAV147L	2525	2825	1608	1908	1105		277.1	1.731	18		LAD10+LAL10+LA16L+LAV70L +LA13L+LAP10+LAD10+2xNL41
LAV148L	2525	3525	1608	2608	1105		303.6	1.855	19		LAD10+LAL10+LA23L+LAV70L +LA13L+LAP10+LAD10+2xNL41
LAV149L	2825	2525	1908	1608	1105		277.1	1.731	18		LAD10+LAL10+LA13L+LAV70L +LA16L+LAP10+LAD10+2xNL41
LAV150L	2825	2825	1908	1908	1105		290.5	1.778	18		LAD10+LAL10+LA16L+LAV70L +LA16L+LAP10+LAD10+2xNL41
LAV151L	2825	3525	1908	2608	1105		317.0	1.902	19		LAD10+LAL10+LA23L+LAV70L +LA16L+LAP10+LAD10+2xNL41

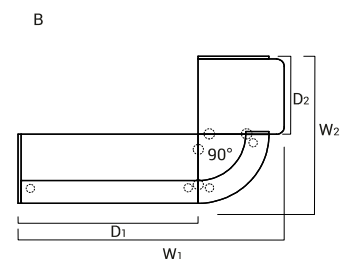
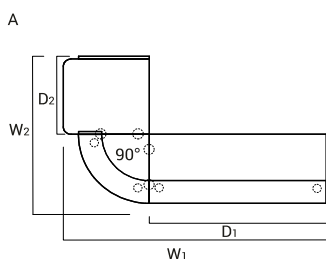
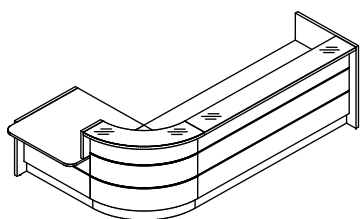

REFERENCIA	DIMENSIONES [mm]						kg	m3	pcs		COMPONENTES
	W <sub>1</sub>	W <sub>2</sub>	D <sub>1</sub>	D <sub>2</sub>	H						
A LAV144L	3442	1955	2318	1038	1105		224.3	1.104	18		LAN2L+LA23L+LAV70L+LAN3P +LAU111L+LAN5P+2xNL41
B LAV145L	3442	1955	2318	1038	1105		224.3	1.104	18		LAN6L+LAU111L+LAN4L+LAV70L +LA23L+LAN1P+2xNL41
A LAV1441L	3442	1755	2318	838	1105		220.3	1.081	18		LAN2L+LA23L+LAV70L+LAN3P +LAU111L+LAN5P+2xNL41
B LAV1451L	3442	1755	2318	838	1105		220.3	1.081	18		LAN6L+LAU111L+LAN4L+LAV70L +LA23L+LAN1P+2xNL41

RECARGO ADICIONAL

CARACTERÍSTICA	PRODUCTO										kg	m3	pcs	COMENTARIOS	
	LAV146L	LAV147L	LAV148L	LAV149L	LAV150L	LAV151L	LAV144L	LAV145L	LAV1441L	LAV1451L					
BANDEJA PARA MONITOR X 1												0.1	0.0001	1	
BANDEJA PARA MONITOR X 2												0.9	0.0070	1	

DESCRIPCIÓN:

- PESO NETO

- VOLUMEN

- NÚMERO DE PAQUETES



## SISTEMAS DE MOSTRADORES DE RECEPCIÓN

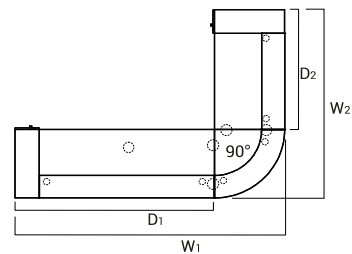
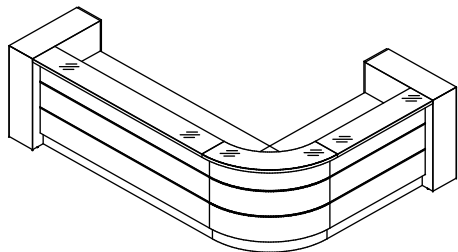

REFERENCIA	DIMENSIONES [mm]										COMPONENTES
	W <sub>1</sub>	W <sub>2</sub>	D <sub>1</sub>	D <sub>2</sub>	H						
LAV152L	3525	2525	2608	1608	1105		303.6	1.855	19		LAD10+LAL10+LA13L+LAV70L +LA23L+LAP10+LAD10+2xNL41
LAV153L	3525	2825	2608	1908	1105		317.0	1.902	19		LAD10+LAL10+LA16L+LAV70L +LA23L+LAP10+LAD10+2xNL41
LAV154L	3525	3525	2608	2608	1105		343.5	2.027	20		LAD10+LAL10+LA23L+LAV70L +LA23L+LAP10+LAD10+2xNL41

## RECARGO ADICIONAL

CARACTERÍSTICA	PRODUCTO													COMENTARIOS	
	LAV152L	LAV153L	LAV154L												
BANDEJA PARA MONITOR X 1												0.1	0.0001	1	
BANDEJA PARA MONITOR X 2												0.9	0.0070	1	

DESCRIPCIÓN:

- PESO NETO

- VOLUMEN

- NÚMERO DE PAQUETES

## SISTEMAS DE MOSTRADORES DE RECEPCIÓN

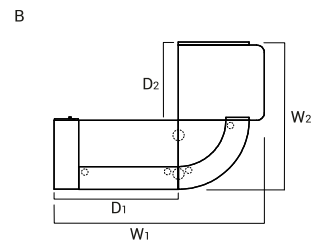
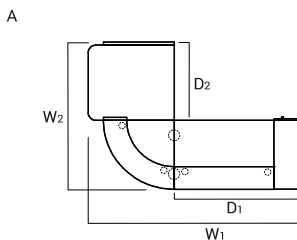
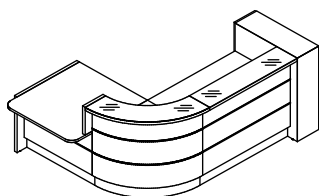

REFERENCIA	DIMENSIONES [mm]						kg	m3	pcs	COMPLEMENTOS
	W <sub>1</sub>	W <sub>2</sub>	D <sub>1</sub>	D <sub>2</sub>	H					
A LAV155L	2722	1955	1608	1038	1105		209.9	1.251	17	LAD10+LAL10+LA13L+LAV70L +LAN3P+LAU11L+LAN5P+2xNL41
B LAV156L	2722	1955	1608	1038	1105		214.4	1.262	18	LAN6L+LAU11L+LAN4L+LAV70L +LA13L+LAP10+LAD10+2xNL41
A LAV157L	3022	1955	1908	1038	1105		223.3	1.299	17	LAD10+LAL10+LA16L+LAV70L +LAN3P+LAU11L+LAN5P+2xNL41
B LAV158L	3022	1955	1908	1038	1105		223.3	1.299	17	LAN6L+LAU11L+LAN4L+LAV70L +LA16L+LAP10+LAD10+2xNL41
A LAV159L	3722	1955	2608	1038	1105		249.8	1.423	18	LAD10+LAL10+LA23L+LAV70L +LAN3P+LAU11L+LAN5P+2xNL41
B LAV160L	3722	1955	2608	1038	1105		249.8	1.423	18	LAN6L+LAU11L+LAN4L+LAV70L +LA23L+LAP10+LAD10+2xNL41
A LAV1551L	2722	1755	1608	838	1105		205.9	1.228	17	LAD10+LAL10+LA13L+LAV70L +LAN3P+LAU11L+LAN5P+2xNL41
B LAV1561L	2722	1755	1608	838	1105		210.4	1.239	18	LAN6L+LAU11L+LAN4L+LAV70L +LA13L+LAP10+LAD10+2xNL41
A LAV1571L	3022	1755	1908	838	1105		219.3	1.275	17	LAD10+LAL10+LA16L+LAV70L +LAN3P+LAU11L+LAN5P+2xNL41
B LAV1581L	3022	1955	1908	838	1105		215.3	1.269	17	LAN6L+LAU11L+LAN4L+LAV70L +LA16L+LAP10+LAD10+2xNL41
A LAV1591L	3722	1755	2608	838	1105		245.8	1.400	18	LAD10+LAL10+LA23L+LAV70L +LAN3P+LAU11L+LAN5P+2xNL41
B LAV1601L	3722	1755	2608	838	1105		245.8	1.400	18	LAN6L+LAU11L+LAN4L+LAV70L +LA23L+LAP10+LAD10+2xNL41

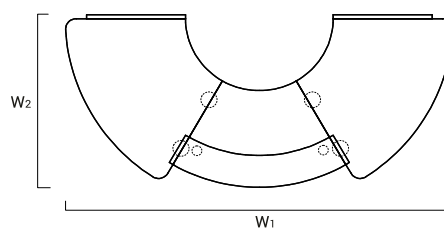
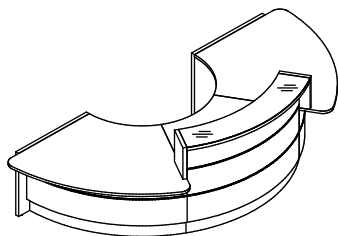

REFERENCIA	DIMENSIONES [mm]						kg	m3	pcs	COMPLEMENTOS
	W <sub>1</sub>	W <sub>2</sub>	D <sub>1</sub>	D <sub>2</sub>	H					
LAV05L	3589	1629			1105		224.1	1.781	17	LAN6L+2xLAV66L+LAN4L+LAV64L+ LAN3P+LAN5P+2xNL41

## RECARGO ADICIONAL

CARACTERÍSTICA	PRODUCTO												kg	m3	pcs	COMENTARIOS	
	LAV155L	LAV156L	LAV157L	LAV158L	LAV159L	LAV160L	LAV1551L	LAV1561L	LAV1571L	LAV1581L	LAV1591L	LAV1601L					LAV05L
BANDEJA PARA MONITOR X 1														0.1	0.0001	1	

DESCRIPCIÓN:

- PESO NETO

- VOLUMEN

- NÚMERO DE PAQUETES

## SISTEMAS DE MOSTRADORES DE RECEPCIÓN

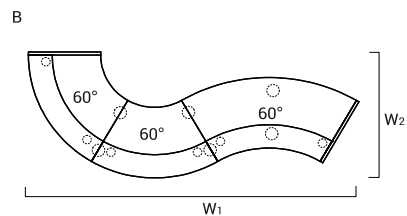
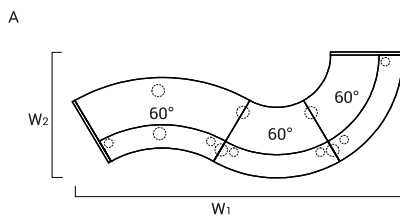
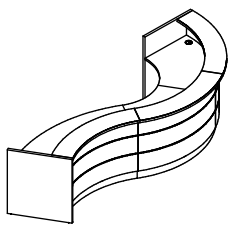

REFERENCIA	DIMENSIONES [mm]						kg	m3	pcs	COMPLEMENTOS
	W <sub>1</sub>	W <sub>2</sub>	D <sub>1</sub>	D <sub>2</sub>	H					
A <b>LAV06L</b>	4199	1629			1105		269.5	2.345	20	LAN2L+2xLAV64L+LAV62L+LAN1P+2xNL41
B <b>LAV07L</b>	4199	1629			1105		269.5	2.345	20	LAN2L+LAV62L+2xLAV64L+LAN1P+2xNL41

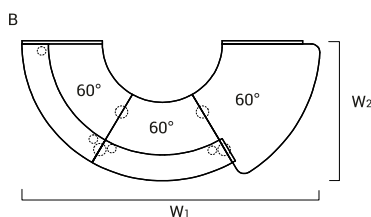
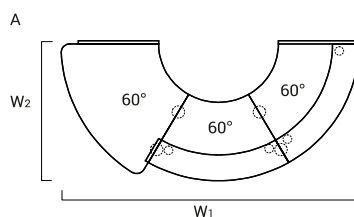
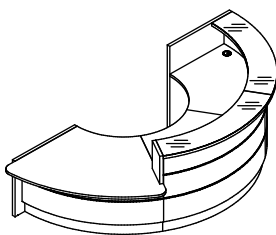

REFERENCIA	DIMENSIONES [mm]						kg	m3	pcs	COMPLEMENTOS
	W <sub>1</sub>	W <sub>2</sub>	D <sub>1</sub>	D <sub>2</sub>	H					
A <b>LAV08L</b>	3367	1629			1105		235.3	2.009	16	LAN2L+2xLAV64L+LAN3P+LAV66L+LAN5P+2xNL41
B <b>LAV09L</b>	3367	1629			1105		235.3	2.009	16	LAN6L+LAV66L+LAN4L+2xLAV64L+LAN1P+2xNL41

## RECARGO ADICIONAL

CARACTERÍSTICA	PRODUCTO										kg	m3	pcs	COMENTARIOS
	LAV06L	LAV07L	LAV08L	LAV09L										
BANDEJA PARA MONITOR X 1											0.1	0.0001	1	
BANDEJA PARA MONITOR X 2											0.9	0.0070	1	
BANDEJA PARA MONITOR X 3											0.9	0.0070	1	

DESCRIPCIÓN:

- PESO NETO

- VOLUMEN

- NÚMERO DE PAQUETES

SISTEMAS DE MOSTRADORES DE RECEPCIÓN

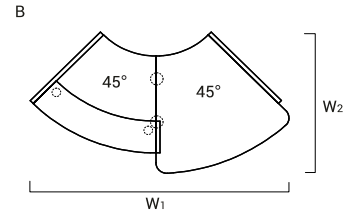
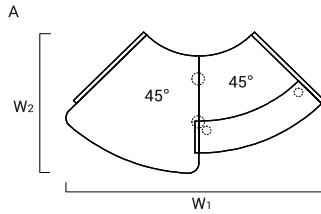
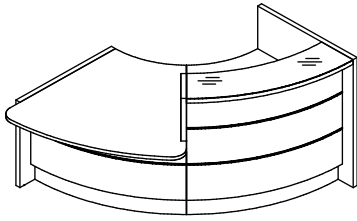

REFERENCIA	DIMENSIONES [mm]					kg	m3	pcs	COMPONENTES
	W <sub>1</sub>	W <sub>2</sub>	D <sub>1</sub>	D <sub>2</sub>	H				
A <b>LAV161L</b>	2320	1114			1105	138.8	0.950	11	LAN2L+LAV63L+LAN3P+LAV65L+LAN5P+NL41
B <b>LAV162L</b>	2320	1114			1105	138.8	0.950	11	LAN6L+LAV65L+LAN4L+LAV63L+LAN1P+NL41

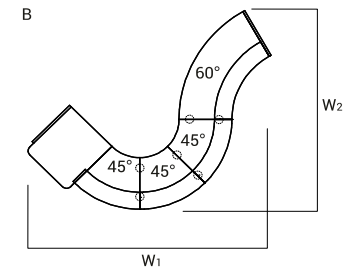
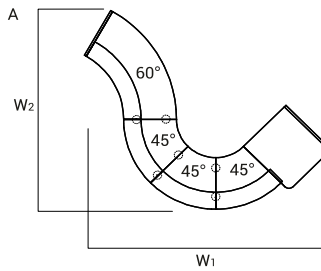
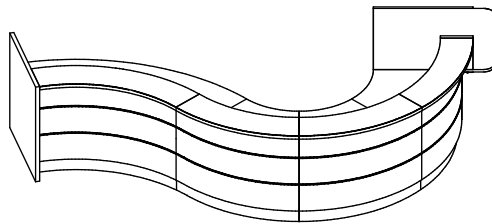

REFERENCIA	DIMENSIONES [mm]					kg	m3	pcs	COMPONENTES
	W <sub>1</sub>	W <sub>2</sub>	D <sub>1</sub>	D <sub>2</sub>	H				
A <b>LAV163L</b>	4080	3540			1105	324.8	2.672	26	LAN6L+LAU111L+LAN4L+3xLAV63L+LAV62L+LAN1P+4xNL41
B <b>LAV164L</b>	4080	3540			1105	324.8	2.672	26	LAN2L+LAV62L+3xLAV63L+LAN3P+LAU111L+LAN5P+4xNL41
A <b>LAV1631L</b>	4080	3540			1105	320.8	2.649	26	LAN6L+LAU111L+LAN4L+3xLAV63L+LAV62L+LAN1P+4xNL41
B <b>LAV1641L</b>	4080	3540			1105	320.8	2.649	26	LAN2L+LAV62L+3xLAV63L+LAN3P+LAU111L+LAN5P+4xNL41

RECARGO ADICIONAL

CARACTERÍSTICA	PRODUCTO						kg	m3	pcs	COMENTARIOS
	LAV163L	LAV164L	LAV1631L	LAV1641L						
BANDEJA PARA MONITOR X 1							0.1	0.0001	1	

DESCRIPCIÓN:

- PESO NETO

- VOLUMEN

- NÚMERO DE PAQUETES

SISTEMAS DE MOSTRADORES DE RECEPCIÓN

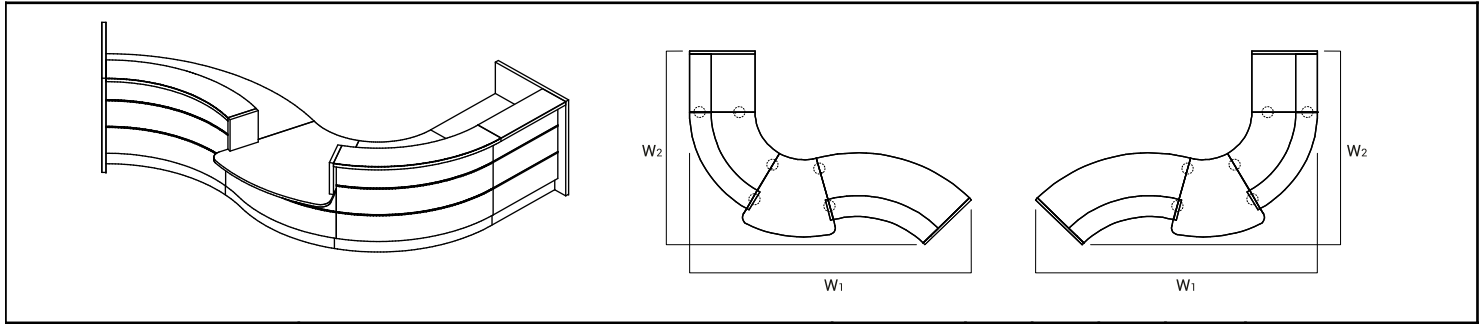

REFERENCIA	DIMENSIONES [mm]									COMONENTES
	W <sub>1</sub>	W <sub>2</sub>	D <sub>1</sub>	D <sub>2</sub>	H					
LAV165L	2677	3946			1105		297.1	2.069	25	LAN2L+LAV62L+LAN3P+LAV65L +LAN4L+LAV63L+LA09L+LAN1P +3xNL41

RECARGO ADICIONAL



CARACTERÍSTICA	PRODUCTO												COMENTARIOS
	LAV165L												
BANDEJA PARA MONITOR X 1										0.1	0.0001	1	

DESCRIPCIÓN:

- PESO NETO

- VOLUMEN



- NÚMERO DE PAQUETES

ILUSTRACIÓN DE PRODUCTO	DIMENSIONES [mm]			REFERENCIA						COMPONENTES
	LARGO	PROFUNDIDAD	ALTURA							

## ELEMENTOS RECTOS

	844	917	1105	<b>LA09L</b>		36.0	0.149	4		
	1290	917	1105	<b>LA13L</b>		53.6	0.223	4		
	1590	917	1105	<b>LA16L</b>		67.0	0.270	4		
	2290	917	1105	<b>LA23L</b>		93.5	0.395	5		encimera con pata de apoyo NE41, 15- blanco brillo
	1290	917	1105	<b>LAP13L</b>		52.6	0.223	4		
	1590	917	1105	<b>LAP16L</b>		66.5	0.270	4		
	2290	917	1105	<b>LAP23L</b>		93.0	0.395	5		encimera con pata de apoyo NE41, 15- blanco brillo
	1290	917	1105	<b>LAL13L</b>		52.6	0.223	4		
	1590	917	1105	<b>LAL16L</b>		66.5	0.270	4		

## RECARGO ADICIONAL

CARACTERÍSTICA	PRODUCTO												COMENTARIOS
	LA13L	LA16L	LA23L	LAP13L	LAP16L	LAP23L	LAL13L	LAL16L					
BANDEJA PARA MONITOR X 1										0.1	0.0001	1	

DESCRIPCIÓN:









 - PESO NETO - VOLUMEN - NÚMERO DE PAQUETES

ILUSTRACIÓN DE PRODUCTO	DIMENSIONES [mm]			REFERENCIA						COMPONENTES
	LARGO	PROFUNDIDAD	ALTURA			kg	m3	pcs		

## ELEMENTOS RECTOS

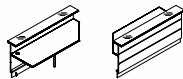
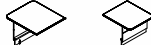
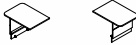
	2290	917	1105	LAL23L		93.0	0.395	5		encimera con pata de apoyo NE41, 15- blanco brillo
	1000	1114	740	LAU11L		32.5	0.123	3		
	800	1114	740	LAU111L		28.5	0.100	3		

## RECARGO ADICIONAL

CARACTERÍSTICA	PRODUCTO													COMENTARIOS
	LAL23L										kg	m3	pcs	
BANDEJA PARA MONITOR X 1											0.1	0.0001	1	

DESCRIPCIÓN:













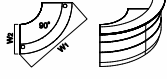
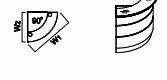

 - PESO NETO - VOLUMEN - NÚMERO DE PAQUETES

ILUSTRACIÓN DE PRODUCTO	DIMENSIONES [mm]			REFERENCIA						COMPONENTES
	LARGO	PROFUNDIDAD	ALTURA							

## ELEMENTOS RADIALES

	2216	917	1105	LAV62L		75.5	0.758	5		
	1600	917	1105	LAV64L		64.5	0.671	4		
	2264	917	1105	LAV90L		105.5	1.043	5		
	1297	917	1105	LAV70L		43.5	0.361	4		
	1225	917	1105	LAV63L		53.5	0.502	4		
	1311	1165	740	LAV65L		35.5	0.291	3		
	1720	1109	740	LAV66L		54.5	0.446	3		
	1485	1109	740	LAV68L		35.5	0.260	3		

## RECARGO ADICIONAL

CARACTERÍSTICA	PRODUCTO												COMENTARIOS
	LAV62L	LAV64L	LAV90L										
BANDEJA PARA MONITOR X 1										0.1	0.0001	1	

DESCRIPCIÓN:





 - PESO NETO - VOLUMEN - NÚMERO DE PAQUETES



ILUSTRACIÓN DE PRODUCTO	DIMENSIONES [mm]			REFERENCIA						COMPONENTES
	LARGO	PROFUNDIDAD	ALTURA							

## ELEMENTOS DE COMPOSICIÓN

	300	300	1105	<b>LA100</b>		22.2	0.115	1		elemento esquinero
	318	917	1105	<b>LAP10</b>		50.0	0.364	1		elemento final con armario - derecha
	318	917	1105	<b>LAL10</b>		50.0	0.364	1		elemento final con armario - izquierda
	306	20	1094	<b>LAD10</b>		4.5	0.011	1		puerta universal para LAP10 y LAL10
	38	917	1105	<b>LAN1P</b>		26.0	0.051	1		panel lateral derecho para unidades altas
	38	917	1105	<b>LAN2L</b>		26.0	0.051	1		panel lateral izquierdo para unidades altas
	38	300	364	<b>LAN3P</b>		2.8	0.007	1		panel lateral superior derecho para la unión de elementos bajos y altos
	38	300	364	<b>LAN4L</b>		2.8	0.007	1		panel lateral superior izquierdo para la unión de elementos bajos y altos
	38	917	740	<b>LAN5P</b>		19.0	0.036	1		panel lateral derecho para unidades bajas
	38	917	740	<b>LAN6L</b>		19.0	0.036	1		panel lateral izquierdo para unidades bajas

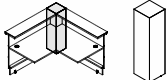
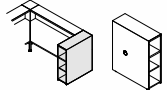
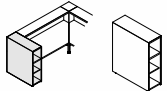
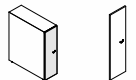
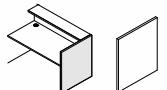
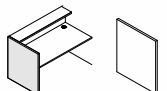
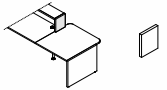
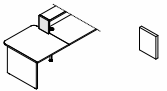
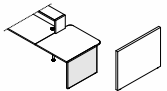
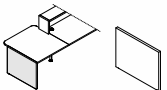
DESCRIPCIÓN:











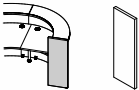
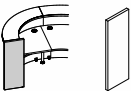
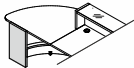
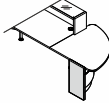

 - PESO NETO - VOLUMEN - NÚMERO DE PAQUETES

ILUSTRACIÓN DE PRODUCTO	DIMENSIONES [mm]			REFERENCIA						COMPONENTES
	LARGO	PROFUNDIDAD	ALTURA							

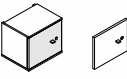
## ELEMENTOS DE COMPOSICIÓN

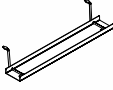
	38	374	1105	<b>LAN7P</b>		11.0	0.024	1		panel lateral derecho para unidades altas
	38	374	1105	<b>LAN8L</b>		11.0	0.024	1		panel lateral izquierdo para unidades altas
	38	374	740	<b>LAN9L</b>		7.5	0.013	1		
	38	374	740	<b>LAN9P</b>		7.5	0.013	1		
	345	283	314	<b>LMS05</b>		5.0	0.031	1		
	339	18	286	<b>LMS06</b>		2.0	0.005	1		
	585	142	712	<b>NL41</b>		2.0	0.063	1		pata de perfil redondo
	40	40	712	<b>NE41L</b>		1.5	0.002	1		pata de perfil redondo
	460	89	120	<b>E64L</b>		0.5	0.001	1		bandeja horizontal pasacables 09- aluminio
	580	162	123	<b>S69L</b>		1.0	0.015	1		bandeja pasacables 09 - aluminio
	140	70	750	<b>S81L</b>		1.1	0.008	1		pasacables vertical en color 09- aluminio

DESCRIPCIÓN:

 - PESO NETO - VOLUMEN - NÚMERO DE PAQUETES