

TECHNISCHE BESCHREIBUNG

FARBE

OBERPLATTE - GLAS

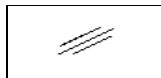

WEISS, GLAS
LACOBEL



FRONT HPL



73 WEISS GLANZ



74 ORANGE GLANZ



80 GRÜN GLANZ



81 DUNKELROT
GLANZ



KORPUS



67 WEISS PASTELL



STÜTZFUSS NL41

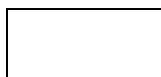

M015 WEISS
HALBMATT

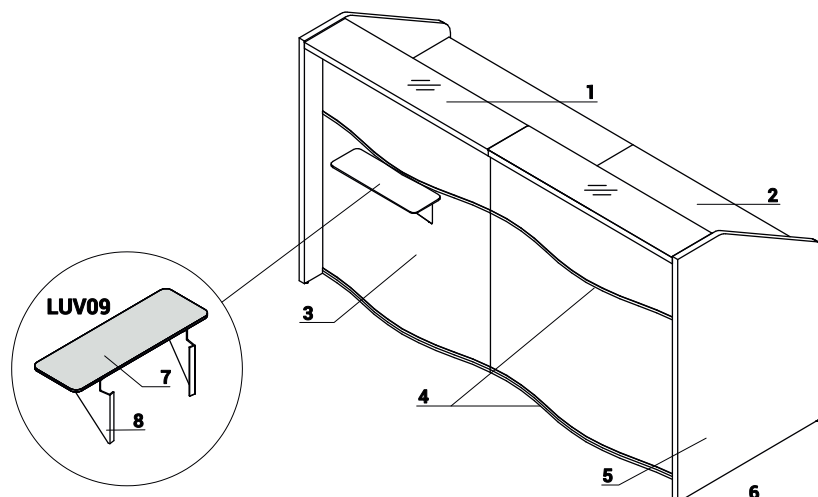

1. **Oberplatte** - Melaminplatte 36mm + Lacobel-Glas 4mm (40mm)
2. **Arbeitsplatte** - Melaminplatte 28mm, Umleimer PVC
3. **HPL - Front** - in Hochglanz
4. **Dekorstreifen** - PVC, M009 - aluminium halbmatt
5. **Niedrige Seite** - Melaminplatte 28mm, Umleimer PVC
6. **Höhenregulierung** - 10mm
7. **Taschenablage** - HPL Weiß Matt 6mm, in der Höhe der Arbeitsplatte montiert, als ein separates Element zu bestellen
8. **Befestigungselement** - Metall, pulverbeschichtet, M015 - weiss halbmatt

TECHNISCHE BESCHREIBUNG

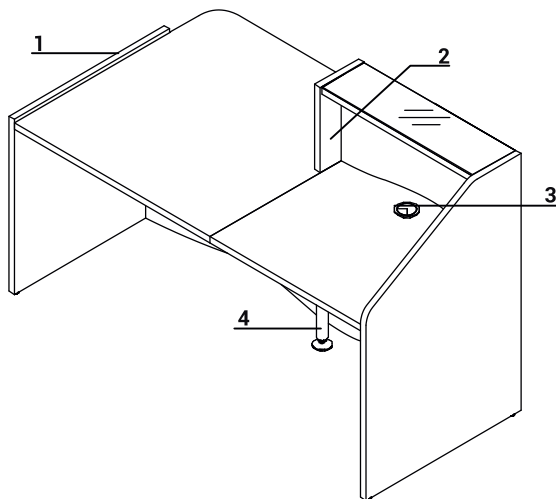

1. **Niedrige Seite** - Melaminplatte 28mm, Umleimer PVC
2. **Seite Verbindung der niedrigen und hohen Theken** - Melaminplatte 28mm, Umleimer PVC
3. **Kabeldurchlässe** - $\varnothing 80\text{mm}$
4. **Stützfuß NL41** - aus Metall, bei Verbindung der Platten notwendig

HINWEISE - Innenseite der Theke in Weiß

VERWENDUNG VON ENDELEMENTEN

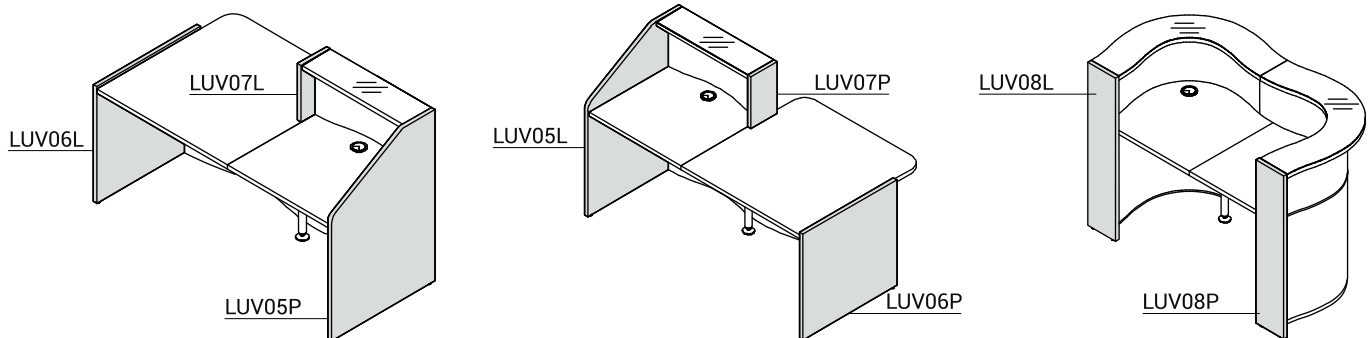

ABMESSUNGEN

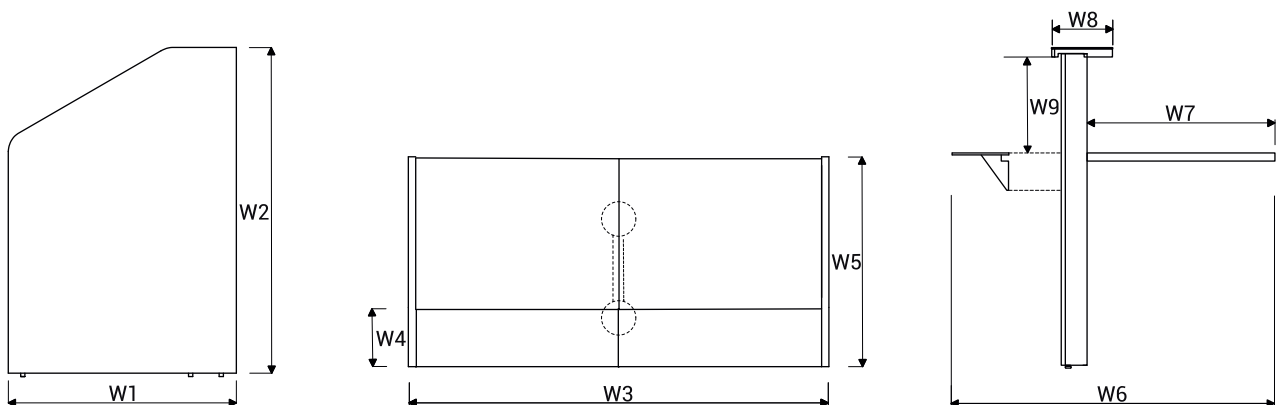

W1 - 770mm | W2 - 1103mm | W3 - 1556mm | W4 - 210mm | W5 - 770mm | W6 - 788mm | W7 - 650mm | W8 - 210mm | W9 - 330mm

EMPFANGSTHEKEN-SYSTEME

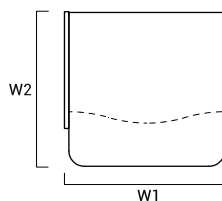
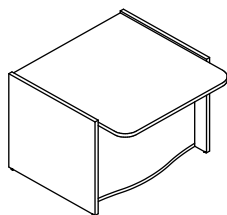

INDEX SYMBOL	ABMESSUNGEN [mm]						kg	m3	pcs		KOMPONENTEN
	W ₁	W ₂	D ₁	D ₂	H						
LUV10	1026	1119			755		50.0	0.167	4		LUV06L+LUV01+LUV06P
LUV101	826	1119			755		44.0	0.141	4		LUV06L+LUV011+LUV06P

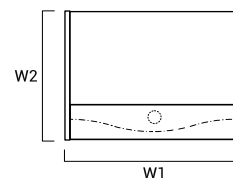
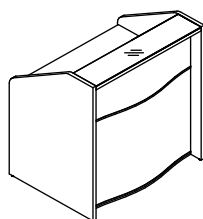

INDEX SYMBOL	ABMESSUNGEN [mm]						kg	m3	pcs		KOMPONENTEN
	W ₁	W ₂	D ₁	D ₂	H						
LUV11	806	770			1103		59.0	0.189	4		LUV05L+LUV02+LUV05P
LUV12	1026	770			1103		63.0	0.226	4		LUV05L+LUV03+LUV05P

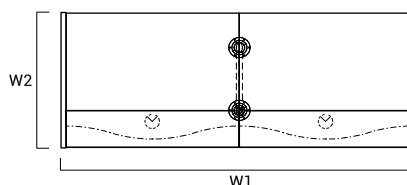
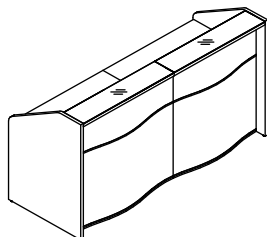

INDEX SYMBOL	ABMESSUNGEN [mm]						kg	m3	pcs		KOMPONENTEN
	W ₁	W ₂	D ₁	D ₂	H						
LUV13	1556	770			1103		90.0	0.380	7		LUV05L+2xLUV02+LUV05P+NL41
LUV14	1996	770			1103		98.0	0.453	7		LUV05L+2xLUV03+LUV05P+NL41

LEGENDE

NETTOGEWICHT

VOLUMEN

STÜCKZAHL DER PAKETE

EMPFANGSTHEKEN-SYSTEME

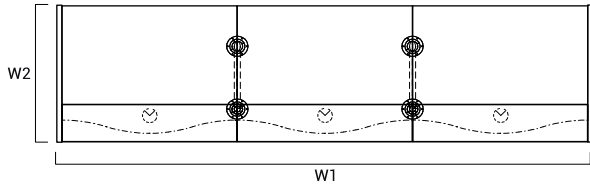
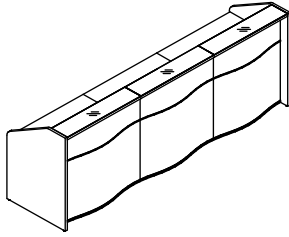

INDEX SYMBOL	ABMESSUNGEN [mm]						kg	m3	pcs	KOMponentEN
	W ₁	W ₂	D ₁	D ₂	H					
LUV15	2306	770			1103		121.0	0.570	10	LUV05L+3xLUV02+LUV05P+2xNL41
LUV16	2966	770			1103		133.0	0.681	10	LUV05L+3xLUV03+LUV05P+2xNL41

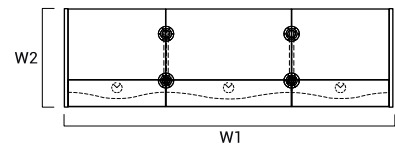
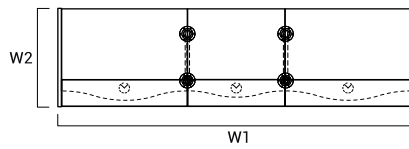
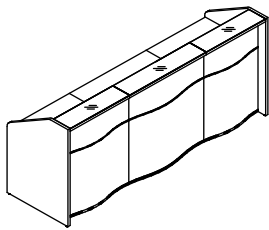

INDEX SYMBOL	ABMESSUNGEN [mm]						kg	m3	pcs	KOMponentEN
	W ₁	W ₂	D ₁	D ₂	H					
LUV17	2746	770			1103		129.0	0.644	10	LUV05L+2xLUV02+LUV03+LUV05P+2xNL41
LUV18	2526	770			1103		125.0	0.607	10	LUV05L+2xLUV03+LUV02+LUV05P+2xNL41

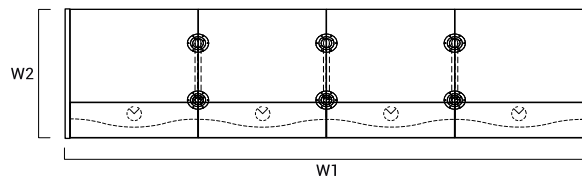
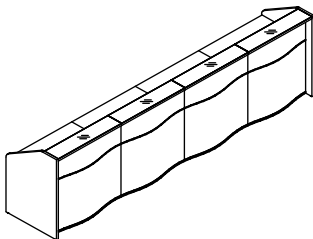

INDEX SYMBOL	ABMESSUNGEN [mm]						kg	m3	pcs	KOMponentEN
	W ₁	W ₂	D ₁	D ₂	H					
LUV19	3496	770			1103		152.0	0.761	13	LUV05L+4xLUV02+LUV05P+3xNL41
LUV20	3936	770			1103		168.0	0.909	13	LUV05L+4xLUV03+LUV05P+3xNL41

LEGENDE

NETTOGEWICHT

VOLUMEN

STÜCKZAHL DER PAKETE

EMPFANGSTHEKEN-SYSTEME

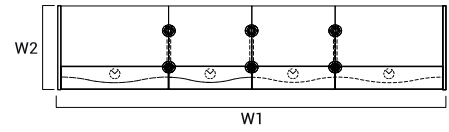
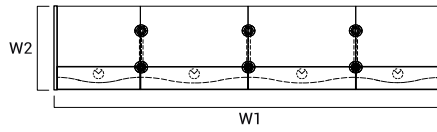
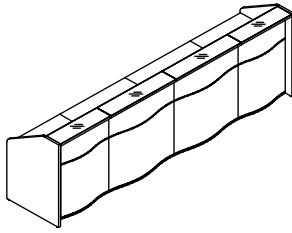

INDEX SYMBOL	ABMESSUNGEN [mm]						kg	m3	pcs	KOMPONENTEN
	W ₁	W ₂	D ₁	D ₂	H					
LUV21	3496	770			1103		160.0	0.835	13	LUV05L+2xLUV02+2xLUV03 +LUV05P+3xNL41

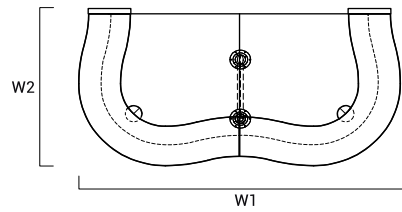
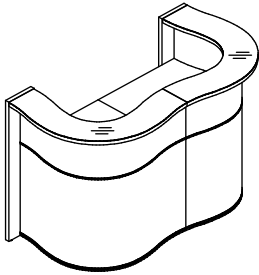

INDEX SYMBOL	ABMESSUNGEN [mm]						kg	m3	pcs	KOMPONENTEN
	W ₁	W ₂	D ₁	D ₂	H					
LUV22	1624	841			1103		84.0	0.575	7	LUV08L+2xLUV04+LUV08P+NL41

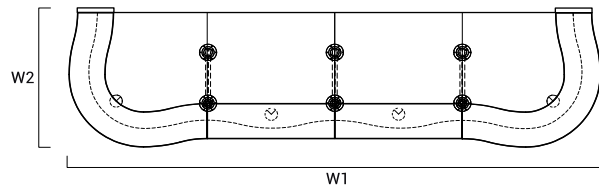
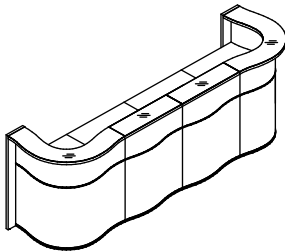

INDEX SYMBOL	ABMESSUNGEN [mm]						kg	m3	pcs	KOMPONENTEN
	W ₁	W ₂	D ₁	D ₂	H					
LUV23	3124	841			1103		146.0	0.957	13	LUV08L+2xLUV04+2xLUV02 +LUV08P+3xNL41
LUV24	3564	841			1103		154.0	1.031	13	LUV08L+2xLUV04+2xLUV03 +LUV08P+3xNL41

LEGENDE

NETTOGEWICHT

VOLUMEN

STÜCKZAHL DER PAKETE

EMPFANGSTHEKEN-SYSTEME

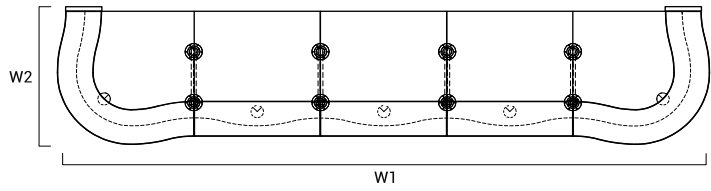
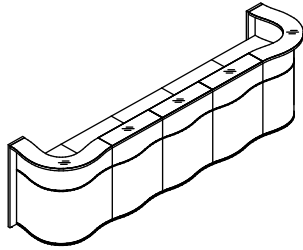

INDEX SYMBOL	ABMESSUNGEN [mm]						kg	m3	pcs	KOMponentEN
	W ₁	W ₂	D ₁	D ₂	H					
LUV25	3874	841			1103		177.0	1.148	16	LUV08L+2xLUV04+3xLUV02 +LUV08P+4xNL41
LUV26	4534	841			1103		189.0	1.259	16	LUV08L+2xLUV04+3xLUV03 +LUV08P+4xNL41

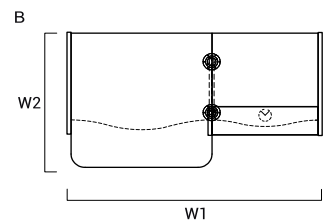
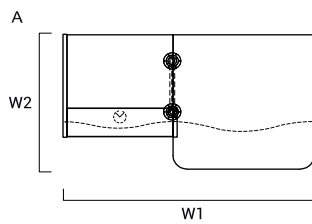
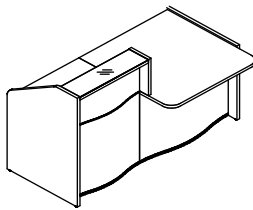

INDEX SYMBOL	ABMESSUNGEN [mm]						kg	m3	pcs	KOMponentEN
	W ₁	W ₂	D ₁	D ₂	H					
A LUV27L	1776	1019			1103		87.0	0.368	8	LUV06L+LUV01+LUV07L+LUV02 +LUV05P+NL41
B LUV27P	1776	1019			1103		87.0	0.368	8	LUV05L+LUV02+LUV07P+LUV01 +LUV06P+NL41
A LUV271L	1576	1019			1103		81.0	0.342	8	LUV06L+LUV01+LUV07L+LUV02 +LUV05P+NL41
B LUV271P	1576	1019			1103		81.0	0.342	8	LUV05L+LUV02+LUV07P+LUV01 +LUV06P+NL41
A LUV28L	1996	1019			1103		91.0	0.405	8	LUV06L+LUV01+LUV07L+LUV03 +LUV05P+NL41
B LUV28P	1996	1019			1103		91.0	0.405	8	LUV05L+LUV03+LUV07P+LUV01 +LUV06P+NL41
A LUV281L	1776	1019			1103		85.0	0.379	8	LUV06L+LUV01+LUV07L+LUV03 +LUV05P+NL41
B LUV281P	1776	1019			1103		85.0	0.379	8	LUV05L+LUV03+LUV07P+LUV01 +LUV06P+NL41

LEGENDE

NETTOGEWICHT

VOLUMEN

STÜCKZAHL DER PAKETE

EMPFANGSTHEKEN-SYSTEME

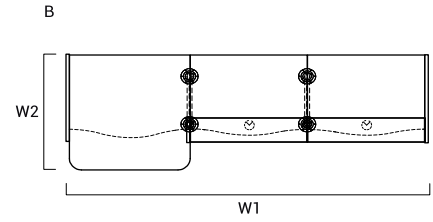
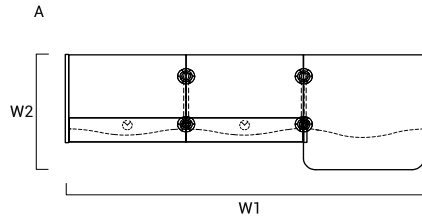
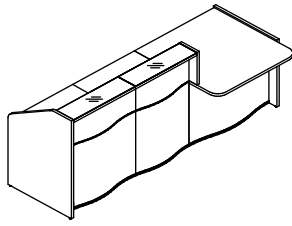

INDEX SYMBOL	ABMESSUNGEN [mm]						kg	m3	pcs	KOMPONENTEN
	W ₁	W ₂	D ₁	D ₂	H					
A LUV29L	2526	1019			1103		118.0	0.559	11	LUV06L+LUV01+LUV07L+2xLUV02+LUV05P+NL41
B LUV29P	2526	1019			1103		118.0	0.559	11	LUV05L+2xLUV02+LUV07P+LUV01+LUV06P+NL41
A LUV291L	2326	1019			1103		112.0	0.533	11	LUV06L+LUV011+LUV07L+2xLUV02+LUV05P+NL41
B LUV291P	2326	1019			1103		112.0	0.533	11	LUV05L+2xLUV02+LUV07P+LUV011+LUV06P+NL41
A LUV30L	2966	1019			1103		126.0	0.633	11	LUV06L+LUV01+LUV07L+2xLUV03+LUV05P+NL41
B LUV30P	2966	1019			1103		126.0	0.633	11	LUV05L+2xLUV03+LUV07P+LUV01+LUV06P+NL41
A LUV301L	2766	1019			1103		120.0	0.607	11	LUV06L+LUV011+LUV07L+2xLUV03+LUV05P+NL41
B LUV301P	2766	1019			1103		120.0	0.607	11	LUV05L+2xLUV03+LUV07P+LUV011+LUV06P+NL41

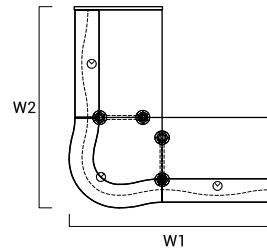
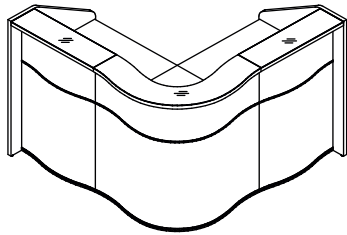

INDEX SYMBOL	ABMESSUNGEN [mm]						kg	m3	pcs	KOMPONENTEN
	W ₁	W ₂	D ₁	D ₂	H					
LUV35	1590	1590			1103		128.0	0.689	10	LUV05L+LUV02+LUV04+LUV02+LUV05P+2xNL41
LUV36	1810	1810			1103		136.0	0.763	10	LUV05L+LUV03+LUV04+LUV03+LUV05P+2xNL41

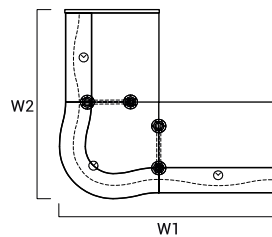
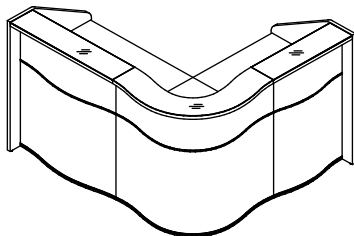

INDEX SYMBOL	ABMESSUNGEN [mm]						kg	m3	pcs	KOMPONENTEN
	W ₁	W ₂	D ₁	D ₂	H					
LUV37	1810	1590			1103		132.0	0.726	10	LUV05L+LUV03+LUV04+LUV02+LUV05P+2xNL41

LEGENDE

NETTOGEWICHT

VOLUMEN

STÜCKZAHL DER PAKETE

EMPFANGSTHEKEN-SYSTEME

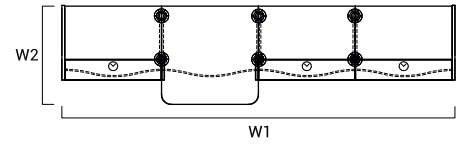
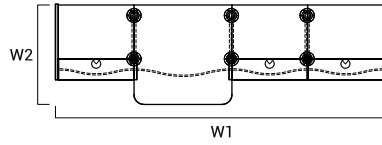
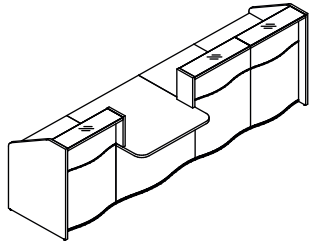

INDEX SYMBOL	ABMESSUNGEN [mm]					kg	m3	pcs	KOMONENTEN
	W ₁	W ₂	D ₁	D ₂	H				
LUV31	3276	1019			1103	155.0	0.759	15	LUV05L+2xLUV02+LUV07P+LUV01+LUV07L+LUV02+LUV05P+3xNL41
LUV311	3076	1019			1103	149.0	0.733	15	LUV05L+2xLUV02+LUV07P+LUV011+LUV07L+LUV02+LUV05P+3xNL41
LUV32	3936	1019			1103	167.0	0.870	15	LUV05L+2xLUV03+LUV07P+LUV01+LUV07L+LUV03+LUV05P+3xNL41
LUV321	3736	1019			1103	161.0	0.844	15	LUV05L+2xLUV03+LUV07P+LUV011+LUV07L+LUV03+LUV05P+3xNL41

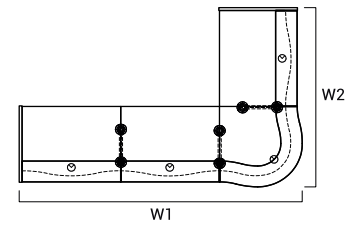
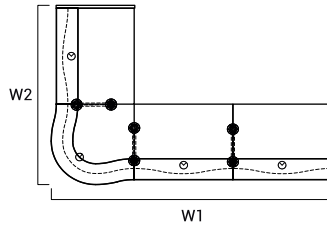
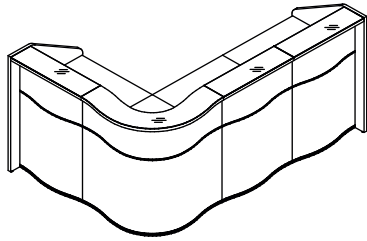

INDEX SYMBOL	ABMESSUNGEN [mm]					kg	m3	pcs	KOMONENTEN
	W ₁	W ₂	D ₁	D ₂	H				
LUV41	2340	1590			1103	159.0	0.879	13	LUV05L+2xLUV02+LUV04+LUV02+LUV05P+3xNL41
LUV42	2780	1810			1103	171.0	0.990	13	LUV05L+2xLUV03+LUV04+LUV03+LUV05P+3xNL41

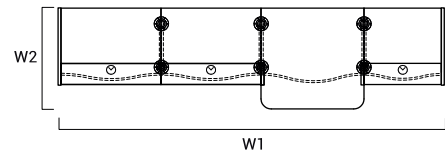
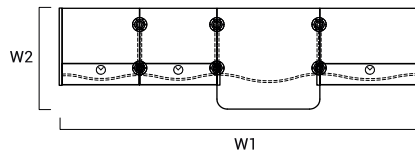
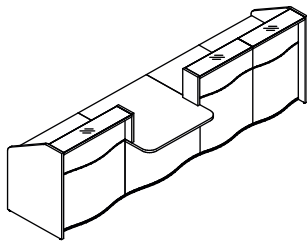

INDEX SYMBOL	ABMESSUNGEN [mm]					kg	m3	pcs	KOMONENTEN
	W ₁	W ₂	D ₁	D ₂	H				
LUV33	3496	1019			1103	159.0	0.796	15	LUV05L+LUV03+LUV07P+LUV01+LUV07L+2xLUV02+LUV05P+3xNL41
LUV331	3296	1019			1103	153.0	0.770	15	LUV05L+LUV03+LUV07P+LUV011+LUV07L+2xLUV02+LUV05P+3xNL41
LUV34	3716	1019			1103	163.0	0.833	15	LUV05L+LUV02+LUV07P+LUV01+LUV07L+2xLUV03+LUV05P+3xNL41
LUV341	3516	1019			1103	157.0	0.807	15	LUV05L+LUV02+LUV07P+LUV011+LUV07L+2xLUV03+LUV05P+3xNL41

LEGENDE

NETTOGEWICHT

VOLUMEN

STÜCKZAHL DER PAKETE

EMPFANGSTHEKEN-SYSTEME

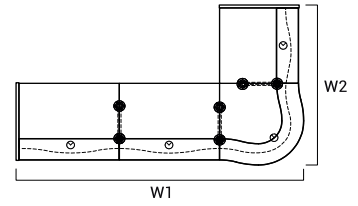
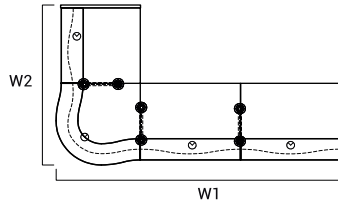
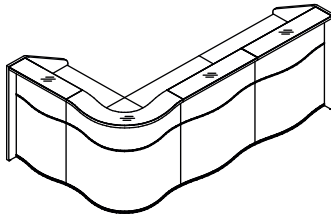

INDEX SYMBOL	ABMESSUNGEN [mm]					PREIS EUR				KOMPONENTEN
	W ₁	W ₂	D ₁	D ₂	H		kg	m ³	pcs	
LUV43	2780	1591	-	-	1103	3 350,-	167.0	0.953	13	LUV05L+2xLUV03+LUV04+LUV02 +LUV05P+3xNL41
LUV44	2343	1813	-	-	1103	3 420,-	163.0	0.916	13	LUV05L+2xLUV02+LUV04+LUV03 +LUV05P+3xNL41

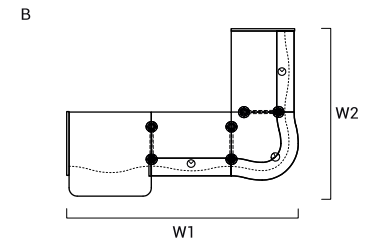
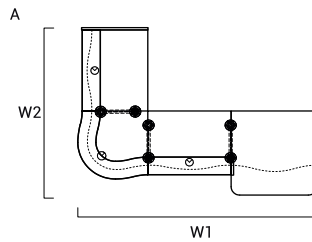
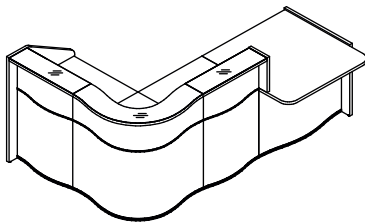

INDEX SYMBOL	ABMESSUNGEN [mm]					PREIS EUR				KOMPONENTEN
	W ₁	W ₂	D ₁	D ₂	H		kg	m ³	pcs	
A LUV38L	2560	1590	-	-	1103	3 335,-	156.0	0.868	14	LUV06L+LUV01+LUV07L +LUV02+LUV04+LUV02+LUV05P +3xNL41
B LUV38P	2560	1590	-	-	1103	3 335,-	156.0	0.868	14	LUV05L+LUV02+LUV04+LUV02 +LUV07P+LUV01+LUV06P+3xNL41
A LUV381L	2360	1590	-	-	1103	3 265,-	150.0	0.842	14	LUV06L+LUV011+LUV07L+LUV02 +LUV04+LUV02+LUV05P+3xNL41
B LUV381P	2360	1590	-	-	1103	3 265,-	150.0	0.842	14	LUV05L+LUV02+LUV04+LUV02 +LUV07P+LUV011+LUV06P +3xNL41
A LUV39L	2780	1810	-	-	1103	3 475,-	164.0	0.942	14	LUV06L+LUV01+LUV07L+LUV03 +LUV04+LUV03+LUV05P+3xNL41
B LUV39P	2780	1810	-	-	1103	3 475,-	164.0	0.942	14	LUV05L+LUV03+LUV04+LUV03 +LUV07P+LUV01+LUV06P+3xNL41
A LUV391L	2580	1810	-	-	1103	3 405,-	158.0	0.916	14	LUV06L+LUV011+LUV07L+LUV03 +LUV04+LUV03+LUV05P+3xNL41
B LUV391P	2580	1810	-	-	1103	3 405,-	158.0	0.916	14	LUV05L+LUV03+LUV04+LUV03 +LUV07P+LUV011+LUV06P +3xNL41

LEGENDE

NETTOGEWICHT

VOLUMEN

STÜCKZAHL DER PAKETE

EMPFANGSTHEKEN-SYSTEME

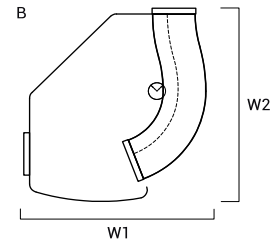
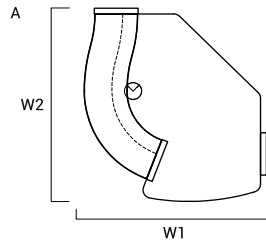
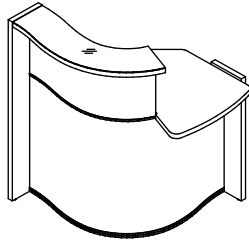

INDEX SYMBOL	ABMESSUNGEN [mm]										KOMponentEN
	W ₁	W ₂	D ₁	D ₂	H						
A LUV49L	858	925			1103		39.0	0.231	2		
B LUV49P	858	925			1103		39.0	0.231	2		

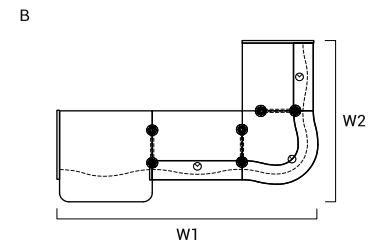
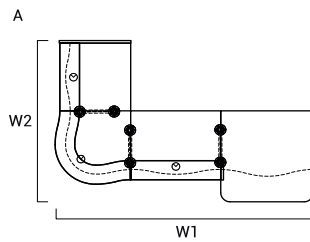
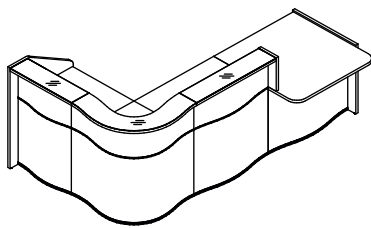

INDEX SYMBOL	ABMESSUNGEN [mm]										KOMponentEN
	W ₁	W ₂	D ₁	D ₂	H						
A LUV40L	2780	1792			1103		160.0	0.905	14		LUV06L+LUV01+LUV07L+LUV03 +LUV04+LUV02+LUV05P+3xNL41
B LUV40P	2780	1792			1103		160.0	0.905	14		LUV05L+LUV02+LUV04+LUV03 +LUV07P+LUV01+LUV06P+3xNL41
A LUV401L	2580	1792			1103		154.0	0.879	14		LUV06L+LUV011+LUV07L+LUV03 +LUV04+LUV02+LUV05P+3xNL41
B LUV401P	2580	1792			1103		154.0	0.879	14		LUV05L+LUV02+LUV04+LUV03 +LUV07P+LUV011+LUV06P +3xNL41

LEGENDE

NETTOGEWICHT

VOLUMEN

STÜCKZAHL DER PAKETE

EMPFANGSTHEKEN-SYSTEME

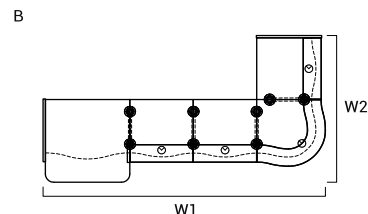
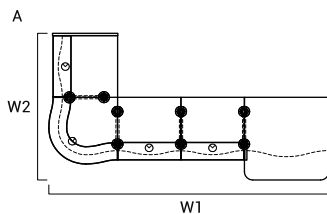
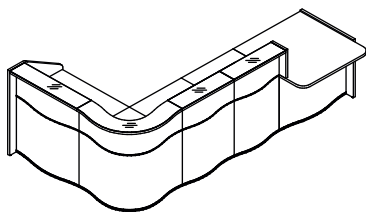

INDEX SYMBOL	ABMESSUNGEN [mm]						kg	m3	pcs	KOMPONENTEN
	W ₁	W ₂	D ₁	D ₂	H					
A LUV45L	3310	1792			1103		187.0	1.059	17	LUV06L+LUV01+LUV07L+2xLUV02+LUV04+LUV02+LUV05P+4xNL41
B LUV45P	3310	1792			1103		187.0	1.059	17	LUV05L+LUV02+LUV04+2xLUV02+LUV07P+LUV01+LUV06P+4xNL41
A LUV451L	3110	1792			1103		181.0	1.033	17	LUV06L+LUV011+LUV07L+2xLUV02+LUV04+LUV02+LUV05P+4xNL41
B LUV451P	3110	1792			1103		181.0	1.033	17	LUV05L+LUV02+LUV04+2xLUV02+LUV07P+LUV011+LUV06P+4xNL41
A LUV46L	3750	1810			1103		199.0	1.169	17	LUV06L+LUV01+LUV07L+2xLUV03+LUV04+LUV03+LUV05P+4xNL41
B LUV46P	3750	1810			1103		199.0	1.169	17	LUV05L+LUV03+LUV04+2xLUV03+LUV07P+LUV01+LUV06P+4xNL41
A LUV461L	3550	1810			1103		193.0	1.144	17	LUV06L+LUV011+LUV07L+2xLUV03+LUV04+LUV03+LUV05P+4xNL41
B LUV461P	3750	1810			1103		193.0	1.144	17	LUV05L+LUV03+LUV04+2xLUV03+LUV07P+LUV011+LUV06P+4xNL41

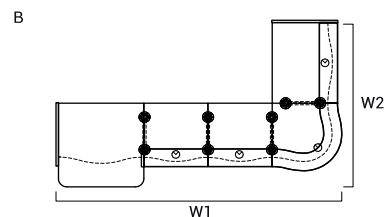
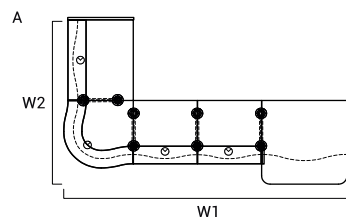
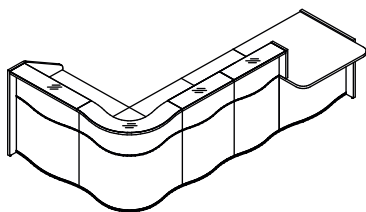



INDEX SYMBOL	ABMESSUNGEN [mm]						kg	m3	pcs	KOMPONENTEN
	W ₁	W ₂	D ₁	D ₂	H					
A LUV47L	3310	1810			1103		195.0	1.133	17	LUV06L+LUV01+LUV07L+2xLUV02+LUV04+LUV03+LUV05P+4xNL41
B LUV47P	3310	1810			1103		195.0	1.133	17	LUV05L+LUV03+LUV04+2xLUV02+LUV07P+LUV01+LUV06P+4xNL41
A LUV471L	3110	1810			1103		189.0	1.107	17	LUV06L+LUV011+LUV07L+2xLUV02+LUV04+LUV03+LUV05P+4xNL41
B LUV471P	3110	1810			1103		189.0	1.107	17	LUV05L+LUV03+LUV04+2xLUV02+LUV07P+LUV011+LUV06P+4xNL41
A LUV48L	3750	1792			1103		191.0	1.096	17	LUV06L+LUV01+LUV07L+2xLUV03+LUV04+LUV02+LUV05P+4xNL41
B LUV48P	3750	1792			1103		191.0	1.096	17	LUV05L+LUV02+LUV04+2xLUV03+LUV07P+LUV01+LUV06P+4xNL41
A LUV481L	3550	1792			1103		185.0	1.070	17	LUV06L+LUV011+LUV07L+2xLUV03+LUV04+LUV02+LUV05P+4xNL41
B LUV481P	3550	1792			1103		185.0	1.070	17	LUV05L+LUV02+LUV04+2xLUV03+LUV07P+LUV011+LUV06P+4xNL41

LEGENDE

NETTOGEWICHT

VOLUMEN

STÜCKZAHL DER PAKETE

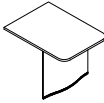
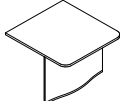
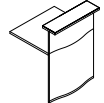
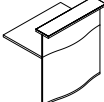
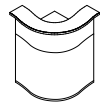
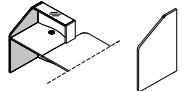
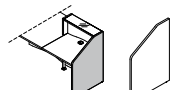
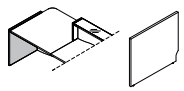
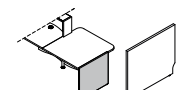
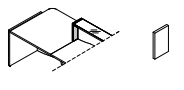
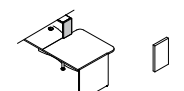

PRODUKTANSICHT UND SKIZZE	ABMESSUNGEN [mm]			INDEX SYMBOL						HINWEISE
	BREITE	TIEFE	HÖHE			kg	m3	pcs		

BESTANDTEILE



	750	1015	740	LUV011		22.0	0.092	2		
	970	1015	740	LUV01		28.0	0.118	2		
	750	763	1103	LUV02		29.0	0.128	2		
	970	763	1103	LUV03		33.0	0.165	2		
	815	815	1103	LUV04		36.0	0.246	2		
	770	28	1103	LUV05L		15.0	0.030	1		Links
	770	28	1103	LUV05P		15.0	0.030	1		Rechts
	770	28	755	LUV06L		11.0	0.024	1		Links
	770	28	755	LUV06P		11.0	0.024	1		Rechts
	216	28	363	LUV07L		2.0	0.004	1		Links
	216	28	363	LUV07P		2.0	0.004	1		Rechts

LEGENDE

 NETTOGEWICHT VOLUMEN STÜCKZAHL DER PAKETE

PRODUKTANSICHT UND SKIZZE	ABMESSUNGEN [mm]			INDEX SYMBOL						HINWEISE
	BREITE	TIEFE	HÖHE			kg	m3	pcs		

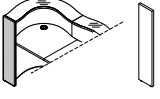
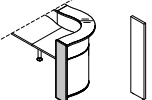
BESTANDTEILE

	216	28	1103	LUV08L		5.0	0.010	1		Links
	216	28	1103	LUV08P		5.0	0.010	1		Rechts
	470	170	170	LUV09		1.7	0.014	0		67 - Weiß Pastell
	585	142	712	NL41		2.0	0.063	1		Rundfuß

LEGENDE

 NETTOGEWICHT

 VOLUMEN

 STÜCKZAHL DER PAKETE