

SPECYFIKACJA TECHNICZNA

KOLORYSTYKA

BLAT GÓRNY - SZKŁO



BIAŁY, LACOBEL



FRONT HPL



73 BIAŁY POŁYSK

0074
POMARAŃCZOWY
POŁYSK80 ZIELONY
POŁYSK81 BORDOWY
POŁYSK

KORPUS



67 BIAŁY PASTEL

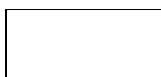
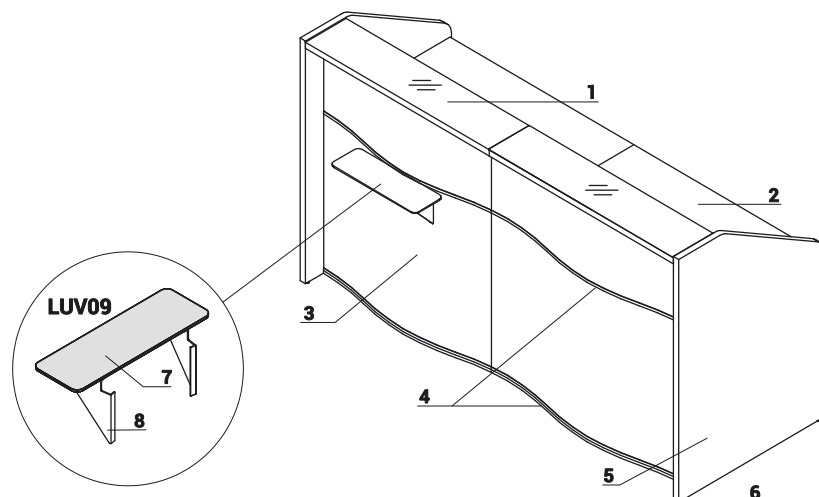

NOGA PODPIERAJĄCA NL41

M015 BIAŁY
PÓŁMAT

1. **Blat górny** - płyta melaminowana 36mm + szkło LACOBEL 4mm (40mm)
2. **Blat roboczy** - płyta melaminowana 28mm, obrzeża PVC
3. **Front** - HPL - połysk
4. **Listwy ozdobne** - PVC, kolor: M009 - aluminium półmat
5. **Noga boczna niska** - płyta melaminowana 28mm, obrzeża PVC
6. **Regulatory poziomu** - regulacja w zakresie 10mm
7. **Opcjonalna półka do lady** - HPL biały mat 6mm, montowana do lady na wysokości blatu roboczego, zamawiana jako osobny element
8. **Mocowanie** - metal malowany proszkowo, kolor: M015 - biały półmat

SPECYFIKACJA TECHNICZNA

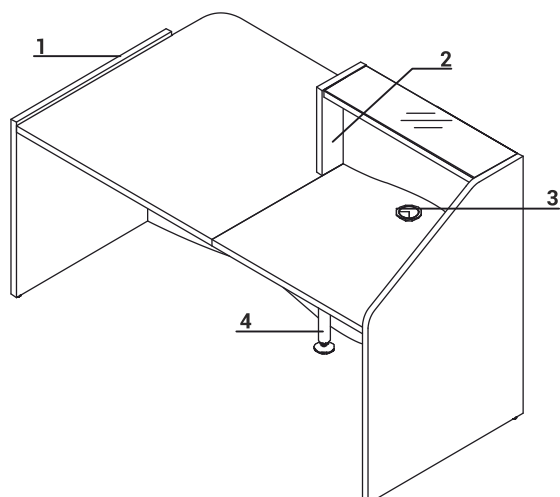

1. **Noga boczna niska** - płyta melaminowana 28mm, obrzeża PVC
2. **Bok łączący lamy niskie i wysokie** - płyta melaminowana 28mm, obrzeża PVC
3. **Przepusty kablowe** - Ø80mm
4. **Noga podpierająca NL41** - metalowa, wymagana na łączeniu blatów

UWAGI - Front od wewnątrz w kolorze białym

ZASTOSOWANIE ELEMENTÓW KOŃCĄCYCH

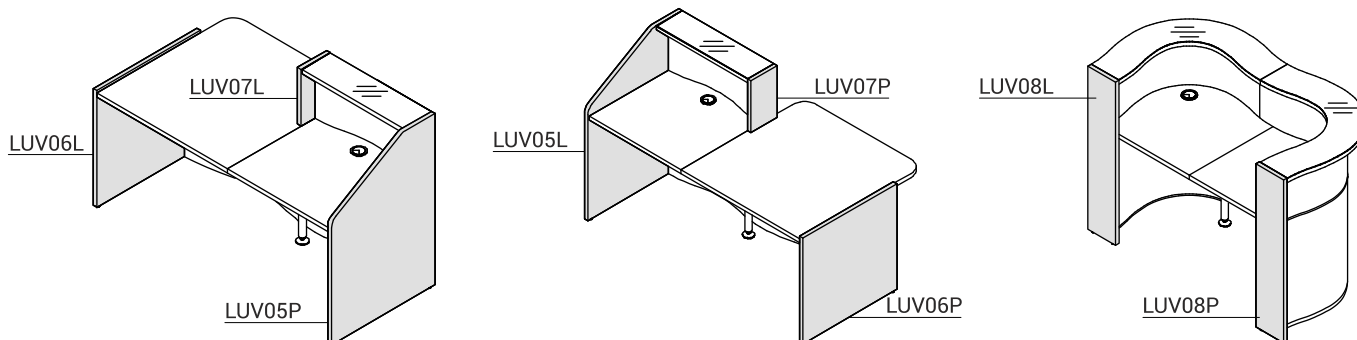

WYMIARY

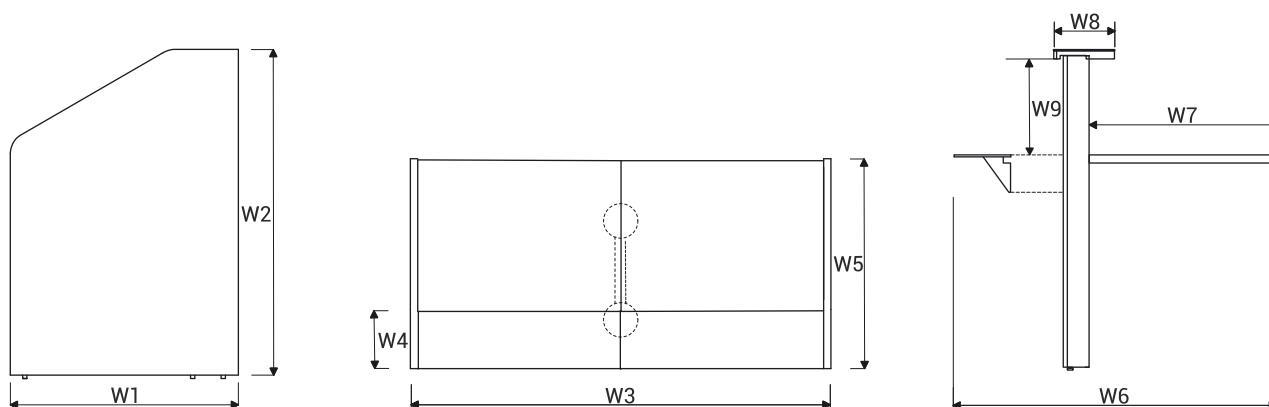

W1 - 770mm | W2 - 1103mm | W3 - 1556mm | W4 - 210mm | W5 - 770mm | W6 - 788mm | W7 - 650mm | W8 - 210mm | W9 - 330mm

UKŁADY LAD

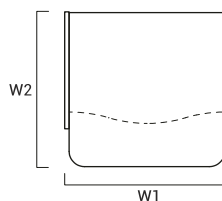
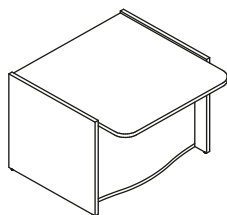

SYMBOL	WYMIARY [mm]					CENA NETTO PLN	kg	m3	szt	ELEMENTY SKŁADOWE
	W ₁	W ₂	D ₁	D ₂	H					
LUV10	1026	1119			755	50.0	0.167	4		LUV06L+LUV01+LUV06P
LUV101	826	1119			755	44.0	0.141	4		LUV06L+LUV011+LUV06P

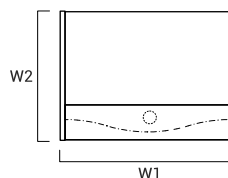
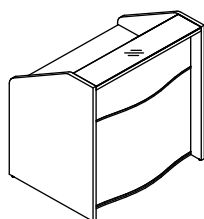

SYMBOL	WYMIARY [mm]					CENA NETTO PLN	kg	m3	szt	ELEMENTY SKŁADOWE
	W ₁	W ₂	D ₁	D ₂	H					
LUV11	806	770			1103	59.0	0.189	4		LUV05L+LUV02+LUV05P
LUV12	1026	770			1103	63.0	0.226	4		LUV05L+LUV03+LUV05P

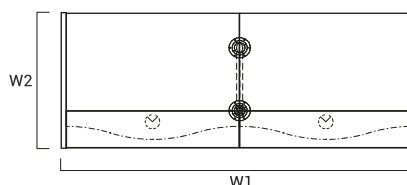
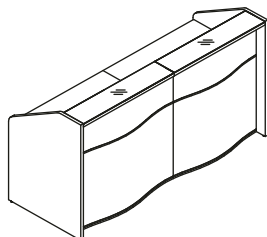

SYMBOL	WYMIARY [mm]					CENA NETTO PLN	kg	m3	szt	ELEMENTY SKŁADOWE
	W ₁	W ₂	D ₁	D ₂	H					
LUV13	1556	770			1103	90.0	0.380	7		LUV05L+2xLUV02+LUV05P+NL41
LUV14	1996	770			1103	98.0	0.453	7		LUV05L+2xLUV03+LUV05P+NL41

LEGENDA:

- WAGA NETTO

- OBJĘTOŚĆ

- ILOŚĆ PACZEK

UKŁADY LAD

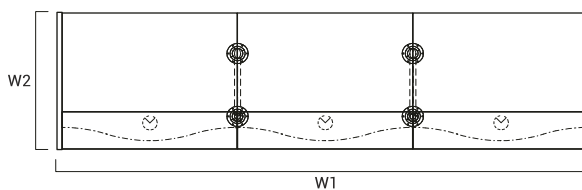
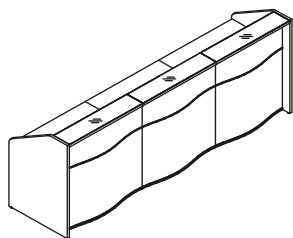

SYMBOL	WYMIARY [mm]					CENA NETTO PLN	kg	m3	szt	ELEMENTY SKŁADOWE
	W ₁	W ₂	D ₁	D ₂	H					
LUV15	2306	770			1103		121.0	0.570	10	LUV05L+3xLUV02+LUV05P+2xNL41
LUV16	2966	770			1103		133.0	0.681	10	LUV05L+3xLUV03+LUV05P+2xNL41

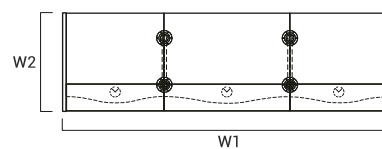
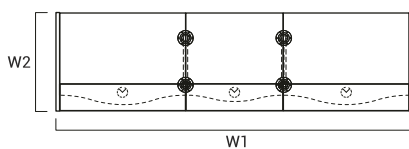
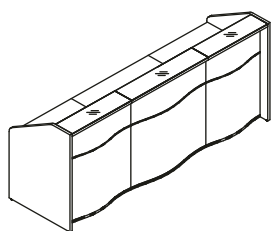

SYMBOL	WYMIARY [mm]					CENA NETTO PLN	kg	m3	szt	ELEMENTY SKŁADOWE
	W ₁	W ₂	D ₁	D ₂	H					
LUV17	2746	770			1103		129.0	0.644	10	LUV05L+2xLUV02+LUV03+LUV05P+2xNL41
LUV18	2526	770			1103		125.0	0.607	10	LUV05L+2xLUV03+LUV02+LUV05P+2xNL41

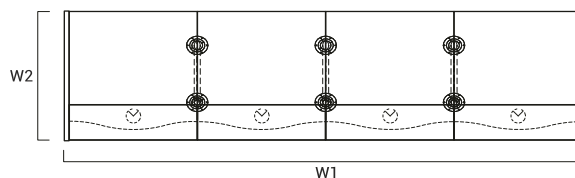
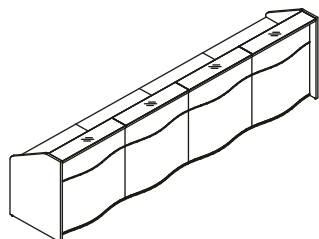

SYMBOL	WYMIARY [mm]					CENA NETTO PLN	kg	m3	szt	ELEMENTY SKŁADOWE
	W ₁	W ₂	D ₁	D ₂	H					
LUV19	3496	770			1103		152.0	0.761	13	LUV05L+4xLUV02+LUV05P+3xNL41
LUV20	3936	770			1103		168.0	0.909	13	LUV05L+4xLUV03+LUV05P+3xNL41

LEGENDA:

- WAGA NETTO

- OBJĘTOŚĆ

- ILOŚĆ PACZEK

UKŁADY LAD

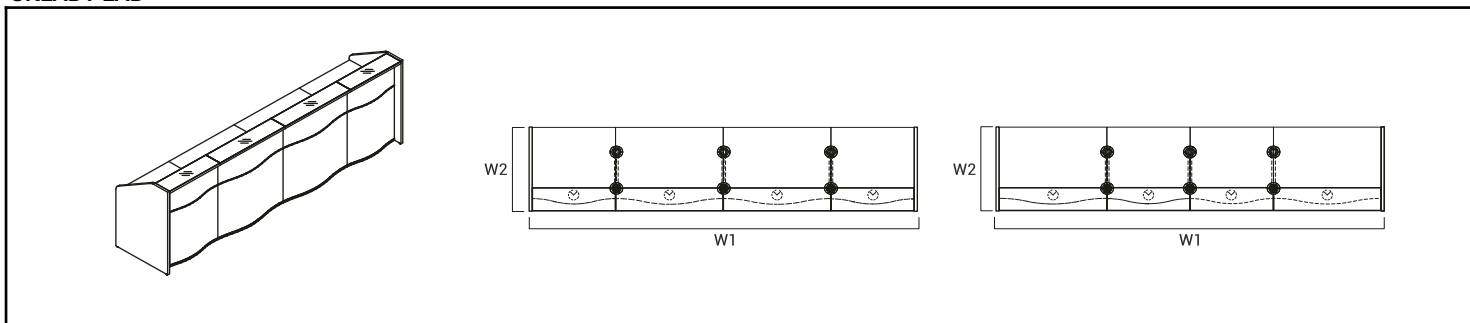

SYMBOL	WYMIARY [mm]					CENA NETTO PLN				ELEMENTY SKŁADOWE
	W ₁	W ₂	D ₁	D ₂	H		kg	m ³	szt	
LUV21	3496	770			1103		160.0	0.835	13	LUV05L+2xLUV02+2xLUV03 +LUV05P+3xNL41

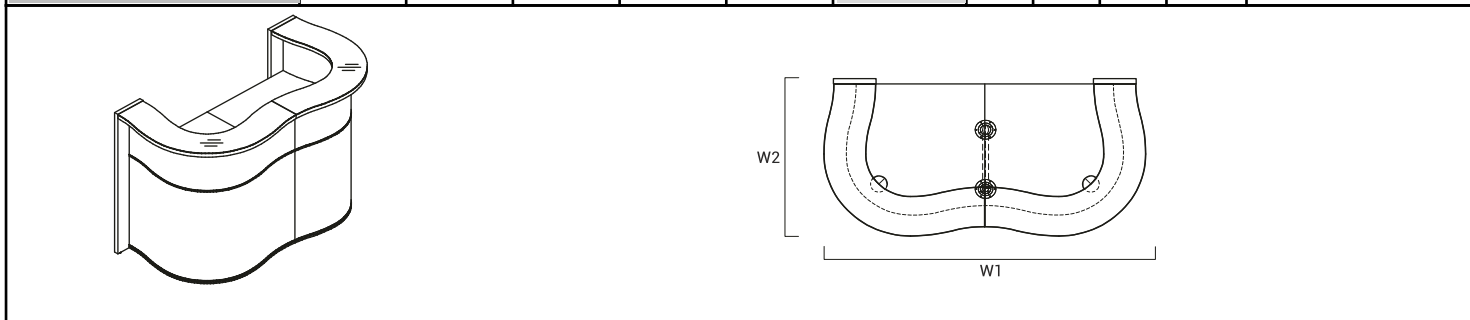

SYMBOL	WYMIARY [mm]					CENA NETTO PLN				ELEMENTY SKŁADOWE
	W ₁	W ₂	D ₁	D ₂	H		kg	m ³	szt	
LUV22	1624	841			1103		84.0	0.575	7	LUV08L+2xLUV04+LUV08P+NL41

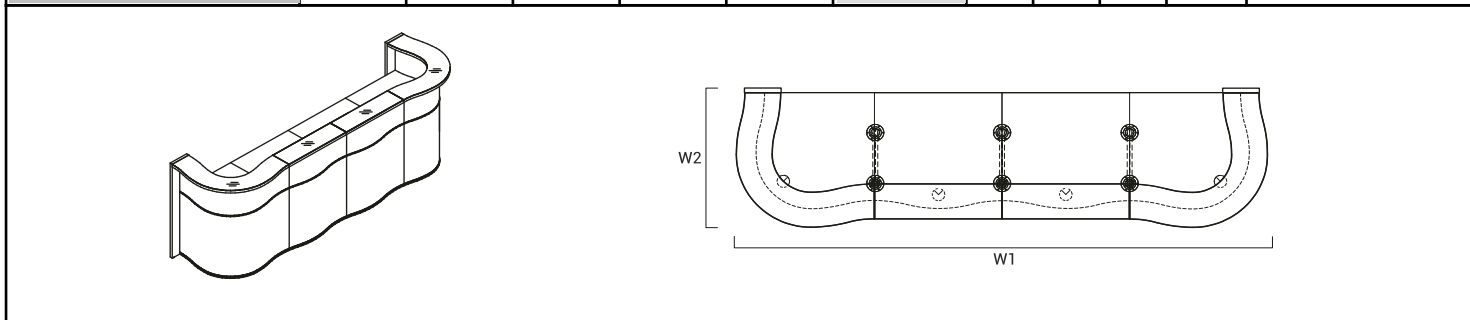

SYMBOL	WYMIARY [mm]					CENA NETTO PLN				ELEMENTY SKŁADOWE
	W ₁	W ₂	D ₁	D ₂	H		kg	m ³	szt	
LUV23	3124	841			1103		146.0	0.957	13	LUV08L+2xLUV04+2xLUV02 +LUV08P+3xNL41
LUV24	3564	841			1103		154.0	1.031	13	LUV08L+2xLUV04+2xLUV03 +LUV08P+3xNL41

LEGENDA:

- WAGA NETTO

- OBJĘTOŚĆ

- ILOŚĆ PACZEK

UKŁADY LAD

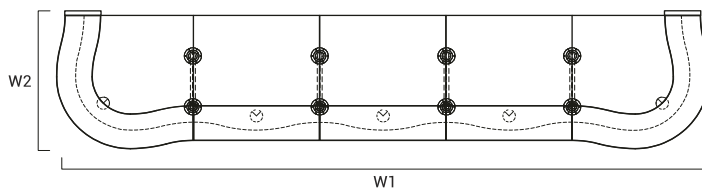
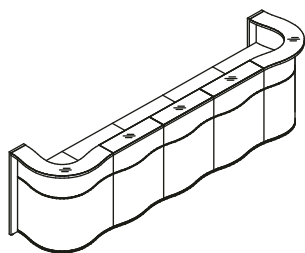

SYMBOL	WYMIARY [mm]					CENA NETTO PLN				ELEMENTY SKŁADOWE
	W ₁	W ₂	D ₁	D ₂	H					
LUV25	3874	841			1103		177.0	1.148	16	LUV08L+2xLUV04+3xLUV02+LUV08P+4xNL41
LUV26	4534	841			1103		189.0	1.259	16	LUV08L+2xLUV04+3xLUV03+LUV08P+4xNL41

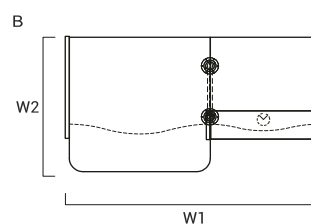
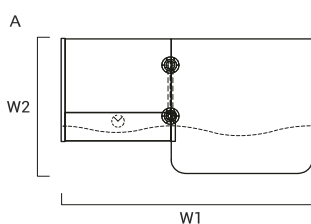
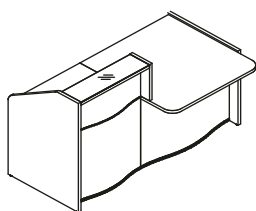

SYMBOL	WYMIARY [mm]					CENA NETTO PLN				ELEMENTY SKŁADOWE
	W ₁	W ₂	D ₁	D ₂	H					
A LUV27L	1776	1019			1103		87.0	0.368	8	LUV06L+LUV01+LUV07L+LUV02+LUV05P+NL41
B LUV27P	1776	1019			1103		87.0	0.368	8	LUV05L+LUV02+LUV07P+LUV01+LUV06P+NL41
A LUV271L	1576	1019			1103		81.0	0.342	8	LUV06L+LUV01+LUV07L+LUV02+LUV05P+NL41
B LUV271P	1576	1019			1103		81.0	0.342	8	LUV05L+LUV02+LUV07P+LUV01+LUV06P+NL41
A LUV28L	1996	1019			1103		91.0	0.405	8	LUV06L+LUV01+LUV07L+LUV03+LUV05P+NL41
B LUV28P	1996	1019			1103		91.0	0.405	8	LUV05L+LUV03+LUV07P+LUV01+LUV06P+NL41
A LUV281L	1776	1019			1103		85.0	0.379	8	LUV06L+LUV01+LUV07L+LUV03+LUV05P+NL41
B LUV281P	1776	1019			1103		85.0	0.379	8	LUV05L+LUV03+LUV07P+LUV01+LUV06P+NL41

LEGENDA:

- WAGA NETTO

- OBJĘTOŚĆ

- ILOŚĆ PACZEK

UKŁADY LAD

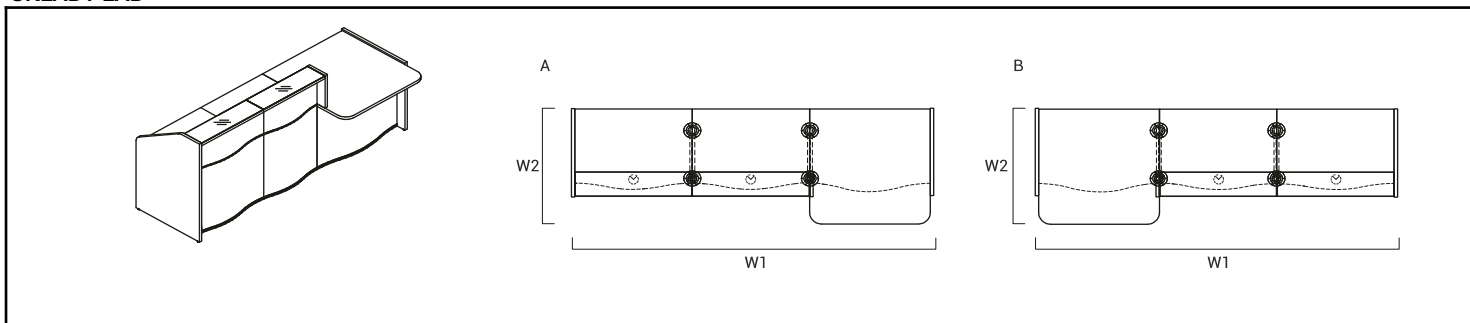

SYMBOL	WYMIARY [mm]					CENA NETTO PLN	kg	m3	szt	ELEMENTY SKŁADOWE
	W ₁	W ₂	D ₁	D ₂	H					
A LUV29L	2526	1019			1103		118.0	0.559	11	LUV06L+LUV01+LUV07L+2xLUV02+LUV05P+NL41
B LUV29P	2526	1019			1103		118.0	0.559	11	LUV05L+2xLUV02+LUV07P+LUV01+LUV06P+NL41
A LUV291L	2326	1019			1103		112.0	0.533	11	LUV06L+LUV011+LUV07L+2xLUV02+LUV05P+NL41
B LUV291P	2326	1019			1103		112.0	0.533	11	LUV05L+2xLUV02+LUV07P+LUV011+LUV06P+NL41
A LUV30L	2966	1019			1103		126.0	0.633	11	LUV06L+LUV01+LUV07L+2xLUV03+LUV05P+NL41
B LUV30P	2966	1019			1103		126.0	0.633	11	LUV05L+2xLUV03+LUV07P+LUV01+LUV06P+NL41
A LUV301L	2766	1019			1103		120.0	0.607	11	LUV06L+LUV011+LUV07L+2xLUV03+LUV05P+NL41
B LUV301P	2766	1019			1103		120.0	0.607	11	LUV05L+2xLUV03+LUV07P+LUV011+LUV06P+NL41

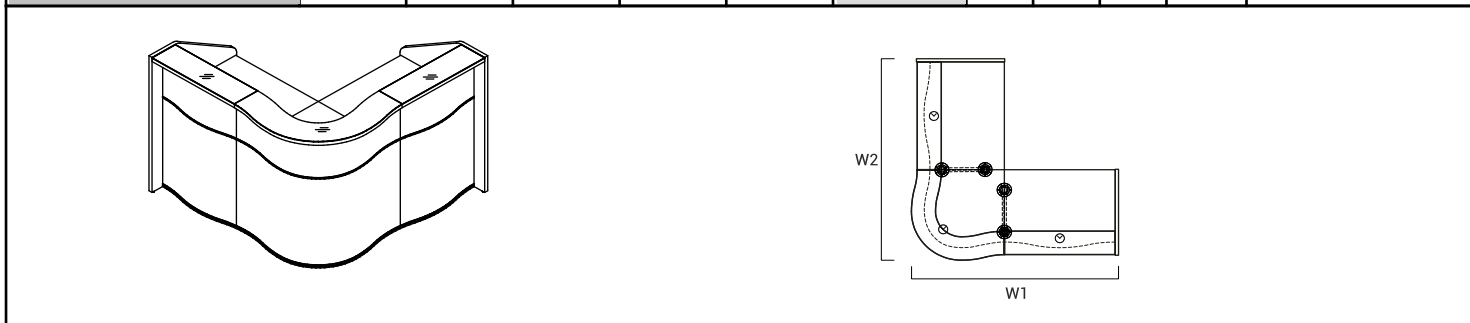

SYMBOL	WYMIARY [mm]					CENA NETTO PLN	kg	m3	szt	ELEMENTY SKŁADOWE
	W ₁	W ₂	D ₁	D ₂	H					
LUV35	1590	1590			1103		128.0	0.689	10	LUV05L+LUV02+LUV04+LUV02+LUV05P+2xNL41
LUV36	1810	1810			1103		136.0	0.763	10	LUV05L+LUV03+LUV04+LUV03+LUV05P+2xNL41

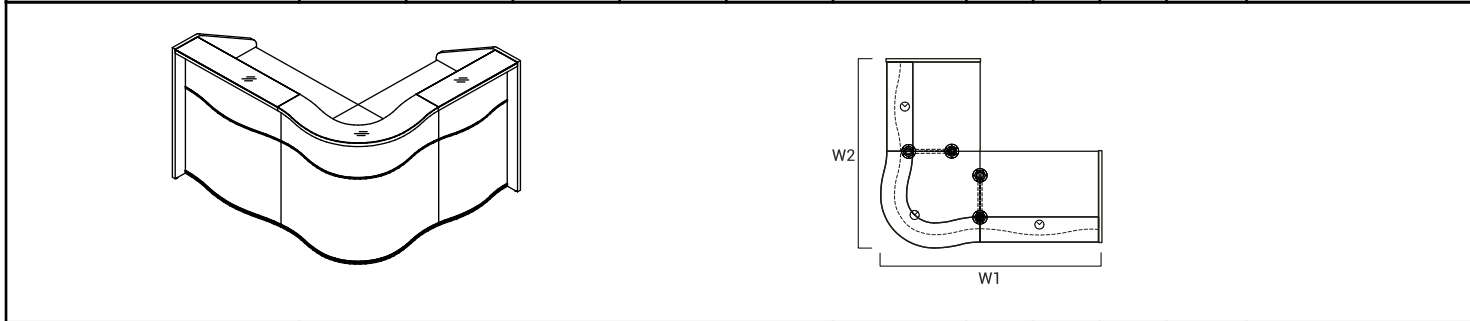

SYMBOL	WYMIARY [mm]					CENA NETTO PLN	kg	m3	szt	ELEMENTY SKŁADOWE
	W ₁	W ₂	D ₁	D ₂	H					
LUV37	1810	1590			1103		132.0	0.726	10	LUV05L+LUV03+LUV04+LUV02+LUV05P+2xNL41

LEGENDA:

- WAGA NETTO

- OBJĘTOŚĆ

- ILOŚĆ PACZEK

UKŁADY LAD

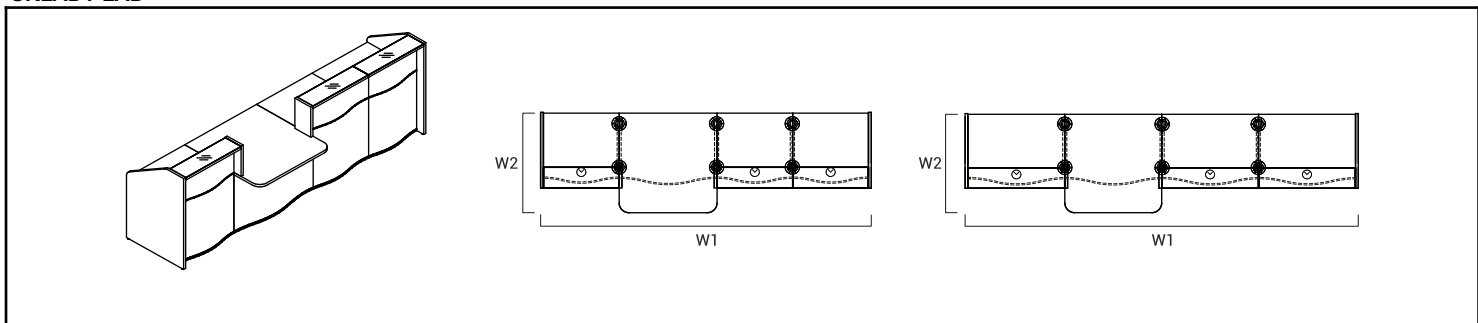

SYMBOL	WYMIARY [mm]					kg	m3	szt	ELEMENTY SKŁADOWE
	W ₁	W ₂	D ₁	D ₂	H				
LUV31	3276	1019			1103	155.0	0.759	15	LUV05L+2xLUV02+LUV07P+LUV01+LUV07L+LUV02+LUV05P+3xNL41
LUV311	3076	1019			1103	149.0	0.733	15	LUV05L+2xLUV02+LUV07P+LUV011+LUV07L+LUV02+LUV05P+3xNL41
LUV32	3936	1019			1103	167.0	0.870	15	LUV05L+2xLUV03+LUV07P+LUV01+LUV07L+LUV03+LUV05P+3xNL41
LUV321	3736	1019			1103	161.0	0.844	15	LUV05L+2xLUV03+LUV07P+LUV011+LUV07L+LUV03+LUV05P+3xNL41

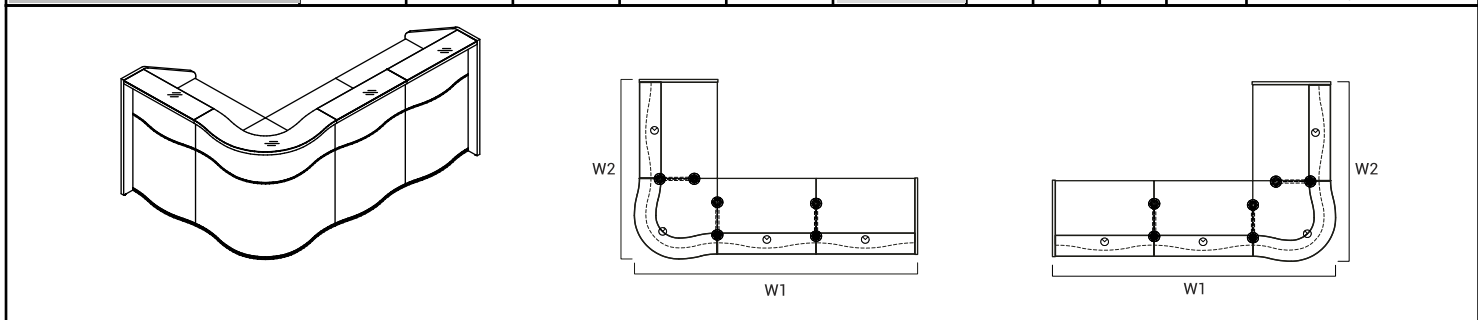

SYMBOL	WYMIARY [mm]					kg	m3	szt	ELEMENTY SKŁADOWE
	W ₁	W ₂	D ₁	D ₂	H				
LUV41	2340	1590			1103	159.0	0.879	13	LUV05L+2xLUV02+LUV04+LUV02+LUV05P+3xNL41
LUV42	2780	1810			1103	171.0	0.990	13	LUV05L+2xLUV03+LUV04+LUV03+LUV05P+3xNL41

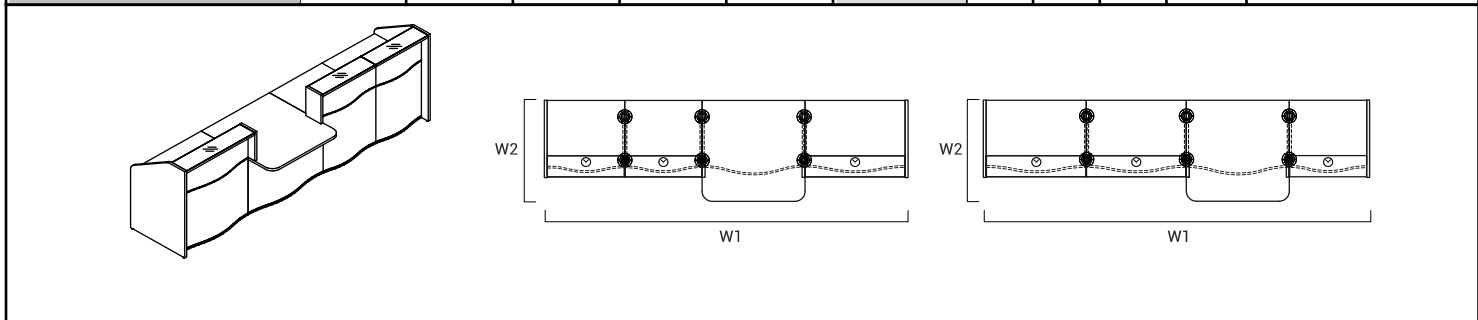

SYMBOL	WYMIARY [mm]					kg	m3	szt	ELEMENTY SKŁADOWE
	W ₁	W ₂	D ₁	D ₂	H				
LUV33	3496	1019			1103	159.0	0.796	15	LUV05L+LUV03+LUV07P+LUV01+LUV07L+2xLUV02+LUV05P+3xNL41
LUV331	3296	1019			1103	153.0	0.770	15	LUV05L+LUV03+LUV07P+LUV011+LUV07L+2xLUV02+LUV05P+3xNL41
LUV34	3716	1019			1103	163.0	0.833	15	LUV05L+LUV02+LUV07P+LUV01+LUV07L+2xLUV03+LUV05P+3xNL41
LUV341	3516	1019			1103	157.0	0.807	15	LUV05L+LUV02+LUV07P+LUV011+LUV07L+2xLUV03+LUV05P+3xNL41

LEGENDA:

- WAGA NETTO

- OBJĘTOŚĆ

- ILOŚĆ PACZEK

UKŁADY LAD

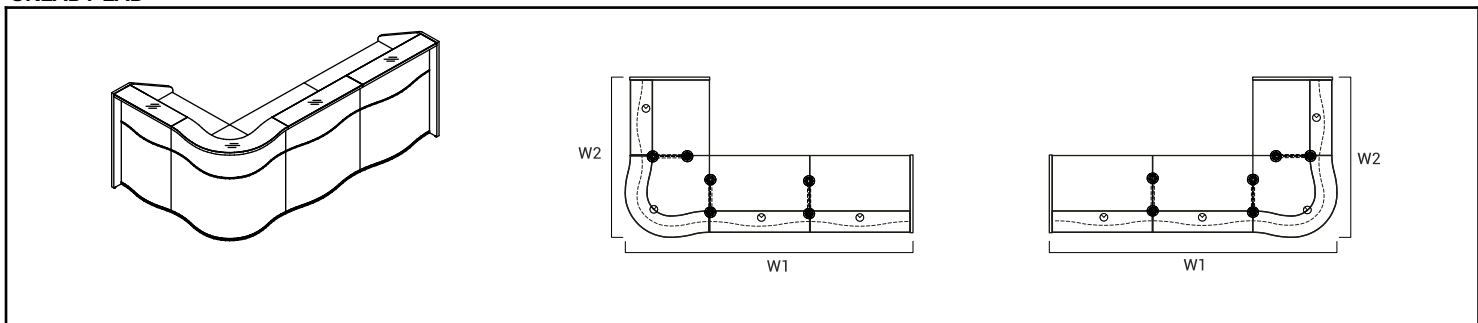

SYMBOL	WYMIARY [mm]					kg	m3	szt	ELEMENTY SKŁADOWE
	W ₁	W ₂	D ₁	D ₂	H				
LUV43	2780	1591			1103	167.0	0.953	13	LUV05L+2xLUV03+LUV04+LUV02+LUV05P+3xNL41
LUV44	2343	1813			1103	163.0	0.916	13	LUV05L+2xLUV02+LUV04+LUV03+LUV05P+3xNL41

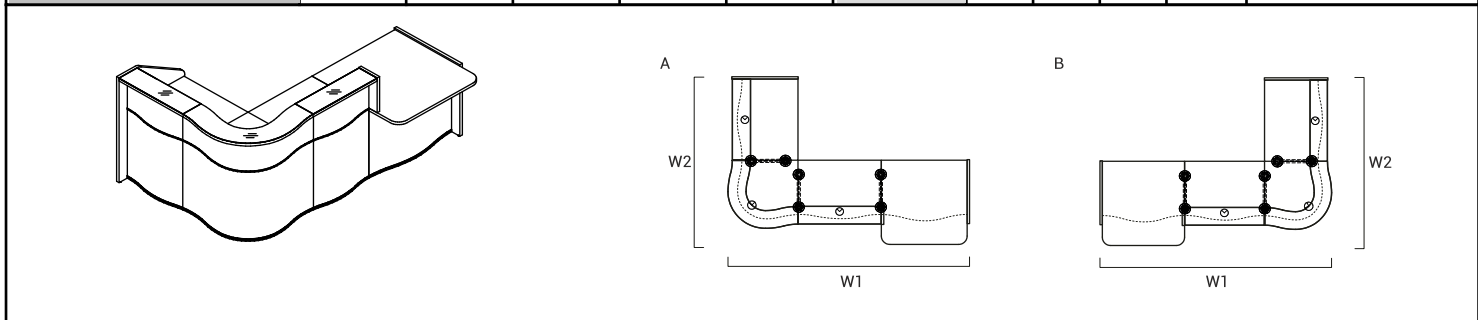

SYMBOL	WYMIARY [mm]					kg	m3	szt	ELEMENTY SKŁADOWE
	W ₁	W ₂	D ₁	D ₂	H				
A LUV38L	2560	1590			1103	156.0	0.868	14	LUV06L+LUV01+LUV07L+LUV02+LUV04+LUV02+LUV05P+3xNL41
B LUV38P	2560	1590			1103	156.0	0.868	14	LUV05L+LUV02+LUV04+LUV02+LUV07P+LUV01+LUV06P+3xNL41
A LUV381L	2360	1590			1103	150.0	0.842	14	LUV06L+LUV011+LUV07L+LUV02+LUV04+LUV02+LUV05P+3xNL41
B LUV381P	2360	1590			1103	150.0	0.842	14	LUV05L+LUV02+LUV04+LUV02+LUV07P+LUV011+LUV06P+3xNL41
A LUV39L	2780	1810			1103	164.0	0.942	14	LUV06L+LUV01+LUV07L+LUV03+LUV04+LUV03+LUV05P+3xNL41
B LUV39P	2780	1810			1103	164.0	0.942	14	LUV05L+LUV03+LUV04+LUV03+LUV07P+LUV01+LUV06P+3xNL41
A LUV391L	2580	1810			1103	158.0	0.916	14	LUV06L+LUV011+LUV07L+LUV03+LUV04+LUV03+LUV05P+3xNL41
B LUV391P	2580	1810			1103	158.0	0.916	14	LUV05L+LUV03+LUV04+LUV03+LUV07P+LUV011+LUV06P+3xNL41

LEGENDA:

- WAGA NETTO

- OBJĘTOŚĆ

- ILOŚĆ PACZEK

UKŁADY LAD

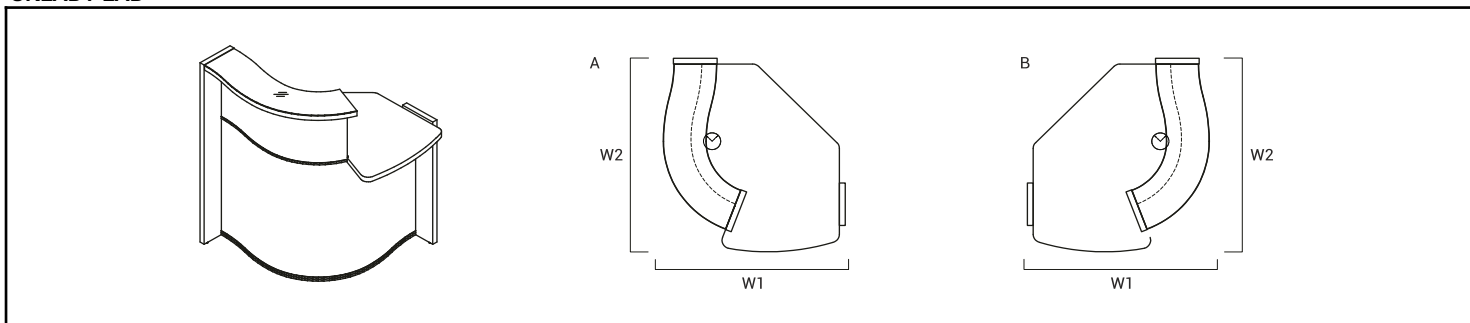

SYMBOL	WYMIARY [mm]					kg	m3	szt	ELEMENTY SKŁADOWE
	W ₁	W ₂	D ₁	D ₂	H				
A LUV49L	858	925			1103	39.0	0.231	2	
B LUV49P	858	925			1103	39.0	0.231	2	

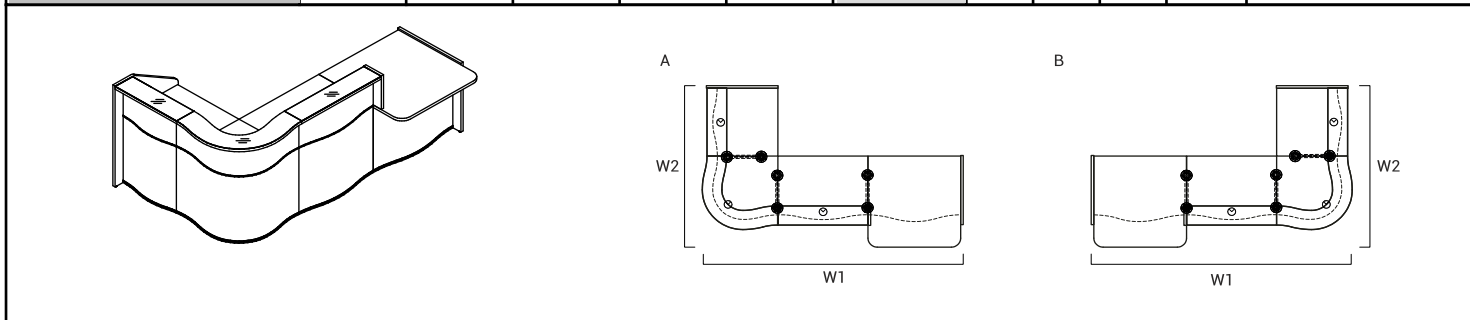

SYMBOL	WYMIARY [mm]					kg	m3	szt	ELEMENTY SKŁADOWE
	W ₁	W ₂	D ₁	D ₂	H				
A LUV40L	2780	1792			1103	160.0	0.905	14	LUV06L+LUV01+LUV07L+LUV03 +LUV04+LUV02+LUV05P+3xNL41
B LUV40P	2780	1792			1103	160.0	0.905	14	LUV05L+LUV02+LUV04+LUV03 +LUV07P+LUV01+LUV06P+3xNL41
A LUV401L	2580	1792			1103	154.0	0.879	14	LUV06L+LUV011+LUV07L+LUV03 +LUV04+LUV02+LUV05P+3xNL41
B LUV401P	2580	1792			1103	154.0	0.879	14	LUV05L+LUV02+LUV04+LUV03 +LUV07P+LUV011+LUV06P +3xNL41

LEGENDA:

- WAGA NETTO

- OBJĘTOŚĆ

- ILOŚĆ PACZEK

UKŁADY LAD

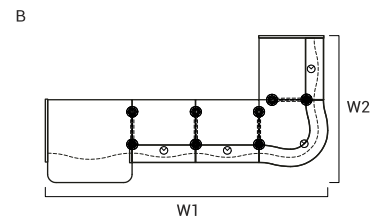
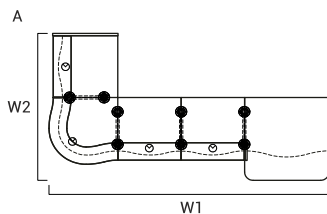
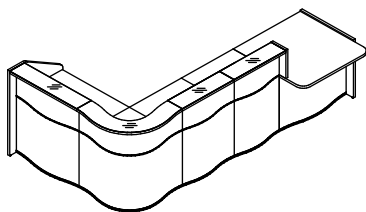

SYMBOL	WYMIARY [mm]					kg	m3	szt	ELEMENTY SKŁADOWE
	W ₁	W ₂	D ₁	D ₂	H				
A LUV45L	3310	1792			1103	187.0	1.059	17	LUV06L+LUV01+LUV07L+2xLUV02+LUV04+LUV02+LUV05P+4xNL41
B LUV45P	3310	1792			1103	187.0	1.059	17	LUV05L+LUV02+LUV04+2xLUV02+LUV07P+LUV01+LUV06P+4xNL41
A LUV451L	3110	1792			1103	181.0	1.033	17	LUV06L+LUV011+LUV07L+2xLUV02+LUV04+LUV02+LUV05P+4xNL41
B LUV451P	3110	1792			1103	181.0	1.033	17	LUV05L+LUV02+LUV04+2xLUV02+LUV07P+LUV011+LUV06P+4xNL41
A LUV46L	3750	1810			1103	199.0	1.169	17	LUV06L+LUV01+LUV07L+2xLUV03+LUV04+LUV03+LUV05P+4xNL41
B LUV46P	3750	1810			1103	199.0	1.169	17	LUV05L+LUV03+LUV04+2xLUV03+LUV07P+LUV01+LUV06P+4xNL41
A LUV461L	3550	1810			1103	193.0	1.144	17	LUV06L+LUV011+LUV07L+2xLUV03+LUV04+LUV03+LUV05P+4xNL41
B LUV461P	3750	1810			1103	193.0	1.144	17	LUV05L+LUV03+LUV04+2xLUV03+LUV07P+LUV011+LUV06P+4xNL41

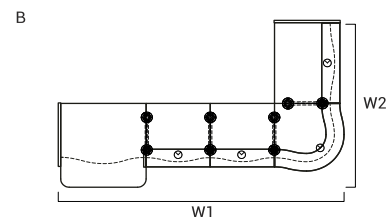
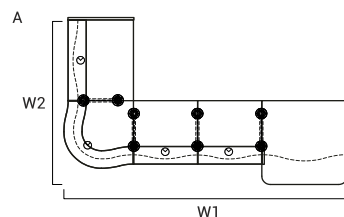
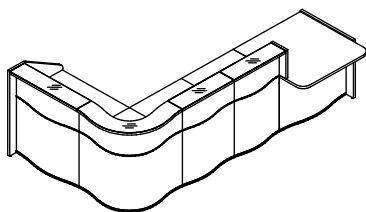



SYMBOL	WYMIARY [mm]					kg	m3	szt	ELEMENTY SKŁADOWE
	W ₁	W ₂	D ₁	D ₂	H				
A LUV47L	3310	1810			1103	195.0	1.133	17	LUV06L+LUV01+LUV07L+2xLUV02+LUV04+LUV03+LUV05P+4xNL41
B LUV47P	3310	1810			1103	195.0	1.133	17	LUV05L+LUV03+LUV04+2xLUV02+LUV07P+LUV01+LUV06P+4xNL41
A LUV471L	3110	1810			1103	189.0	1.107	17	LUV06L+LUV011+LUV07L+2xLUV02+LUV04+LUV03+LUV05P+4xNL41
B LUV471P	3110	1810			1103	189.0	1.107	17	LUV05L+LUV03+LUV04+2xLUV02+LUV07P+LUV011+LUV06P+4xNL41
A LUV48L	3750	1792			1103	191.0	1.096	17	LUV06L+LUV01+LUV07L+2xLUV03+LUV04+LUV02+LUV05P+4xNL41
B LUV48P	3750	1792			1103	191.0	1.096	17	LUV05L+LUV02+LUV04+2xLUV03+LUV07P+LUV01+LUV06P+4xNL41
A LUV481L	3550	1792			1103	185.0	1.070	17	LUV06L+LUV011+LUV07L+2xLUV03+LUV04+LUV02+LUV05P+4xNL41
B LUV481P	3550	1792			1103	185.0	1.070	17	LUV05L+LUV02+LUV04+2xLUV03+LUV07P+LUV011+LUV06P+4xNL41

LEGENDA:

- WAGA NETTO

- OBJĘTOŚĆ



- IŁOŚĆ PACZEK

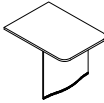
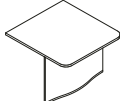
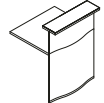
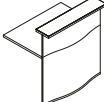
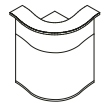
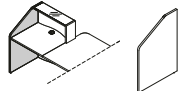
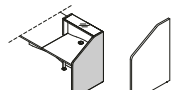
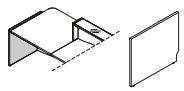
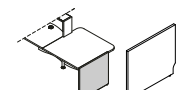
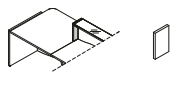
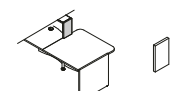

WIDOK I RZUT OBIEKTU	WYMIARY [mm]			SYMBOL						UWAGI
	SZEROKOŚĆ	GŁĘBOKOŚĆ	WYSOKOŚĆ			kg	m3	szt		

ELEMENTY SKŁADOWE



	750	1015	740	LUV011		22.0	0.092	2		
	970	1015	740	LUV01		28.0	0.118	2		
	750	763	1103	LUV02		29.0	0.128	2		
	970	763	1103	LUV03		33.0	0.165	2		
	815	815	1103	LUV04		36.0	0.246	2		
	770	28	1103	LUV05L		15.0	0.030	1		lewy
	770	28	1103	LUV05P		15.0	0.030	1		prawy
	770	28	755	LUV06L		11.0	0.024	1		lewy
	770	28	755	LUV06P		11.0	0.024	1		prawy
	216	28	363	LUV07L		2.0	0.004	1		lewy
	216	28	363	LUV07P		2.0	0.004	1		prawy

LEGENDA:

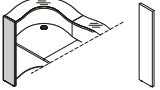
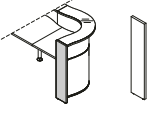

 - WAGA NETTO - OBJĘTOŚĆ - ILOŚĆ PACZEK

WIDOK I RZUT OBIEKTU	WYMIARY [mm]			SYMBOL						UWAGI
	SZEROKOŚĆ	GŁĘBOKOŚĆ	WYSOKOŚĆ			kg	m3	szt		

ELEMENTY SKŁADOWE

	216	28	1103	LUV08L		5.0	0.010	1		lewy
	216	28	1103	LUV08P		5.0	0.010	1		prawy
	470	170	170	LUV09		1.7	0.014	0		67 - biały pastel
	585	142	712	NL41		2.0	0.063	1		noga okrągła

LEGENDA:

 - WAGA NETTO - OBJĘTOŚĆ - ILOŚĆ PACZEK