

CARACTERÍSTICAS TÉCNICAS

COLORES

FRONTAL



34 CASTAÑO



64 CACAO

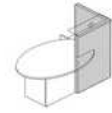

CUERPO



67 BLANCO PASTEL

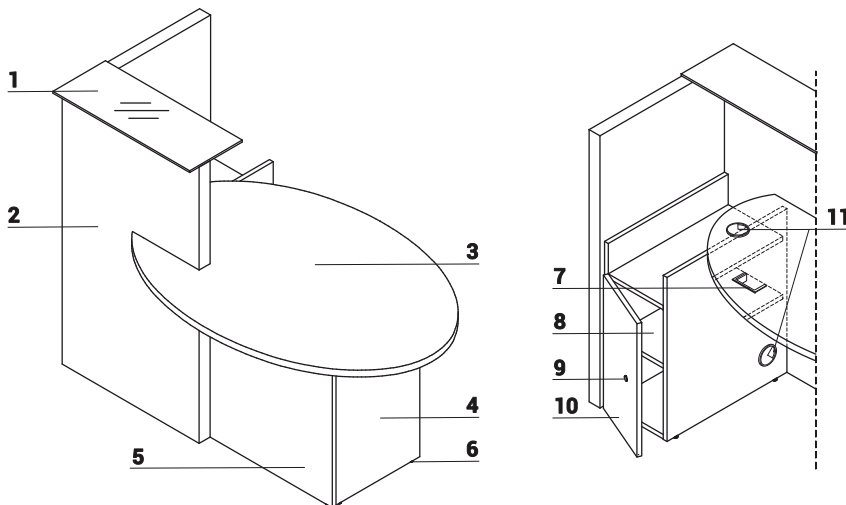
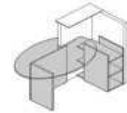

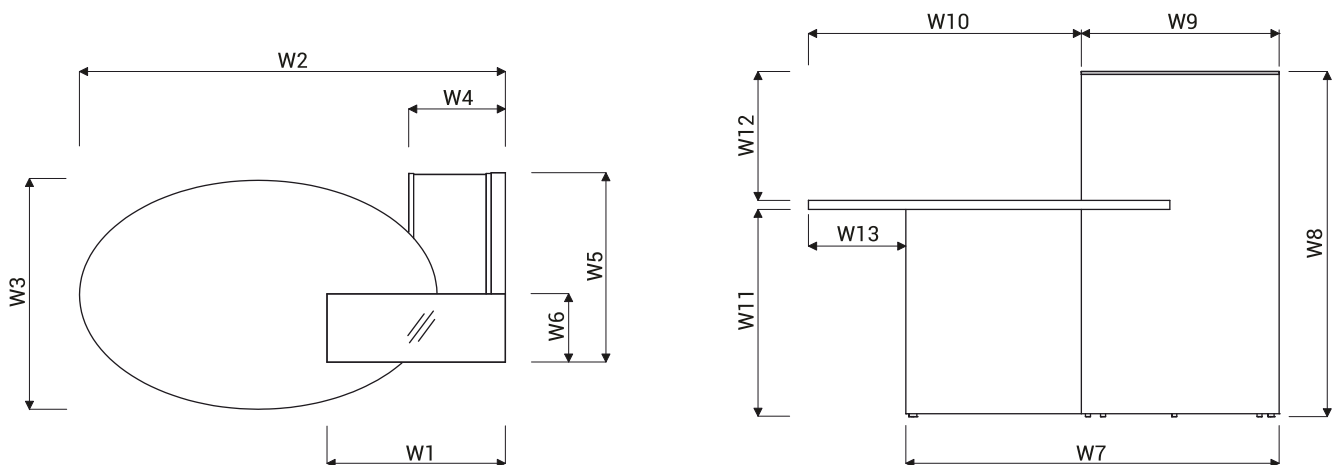

- 1. Encimera - Cristal al ácido templado 8mm
- 2. Frontal - MFC 52mm
- 3. Encimera - MFC 28mm, cantos PVC - con o sin rebajes pasacables
- 4. Cuerpo - MFC 28mm, cantos PVC
- 5. Cuerpo - MFC 18mm, cantos PVC
- 6. Nivelación - 0-5mm
- 7. Tapón pasacables rectangular - 90x48mm
- 8. Armario divisorio - MFC 18mm, cantos PVC
- 9. Cierre patentado
- 10. Frontal - MFC 18mm, cantos PVC
- 11. Tapones pasacables - Ø80mm

DIMENSIONES



W1 - 650mm | W2 - 1548mm | W3 - 870mm | W4 - 352mm | W5 - 695mm | W6 - 250mm | W7 - 1230mm | W8 - 1150mm | W9 - 650mm | W10 - 900mm | W11 - 692mm | W12 - 430mm | W13 - 320mm

| ILUSTRACIÓN DE PRODUCTO | DIMENSIONES [mm] | | | REFERENCIA | |  |  |  | | COMPONENTES |
|-------------------------|------------------|-------------|--------|------------|--|---|---|---|--|-------------|
| | LARGO | PROFUNDIDAD | ALTURA | | | kg | m3 | pcs | | |

MOSTRADOR DE RECEPCIÓN OVO

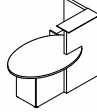
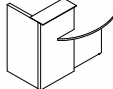
| | | | | | | | | | | |
|---|------|-----|------|--------------|--|------|-------|---|--|--|
|  | 1550 | 870 | 1150 | LOP10 | | 93.0 | 0.240 | 3 | | |
|  | 1550 | 870 | 1150 | LOL10 | | 93.0 | 0.236 | 3 | | |

DESCRIPCIÓN:

 - PESO NETO

 - VOLUMEN

 - NÚMERO DE PAQUETES