

## SPECYFIKACJA TECHNICZNA

## KOLORYSTYKA

## FRONT



34 KASZTAN



64 KAKAO



## KORPUS



67 BIAŁY PASTEL

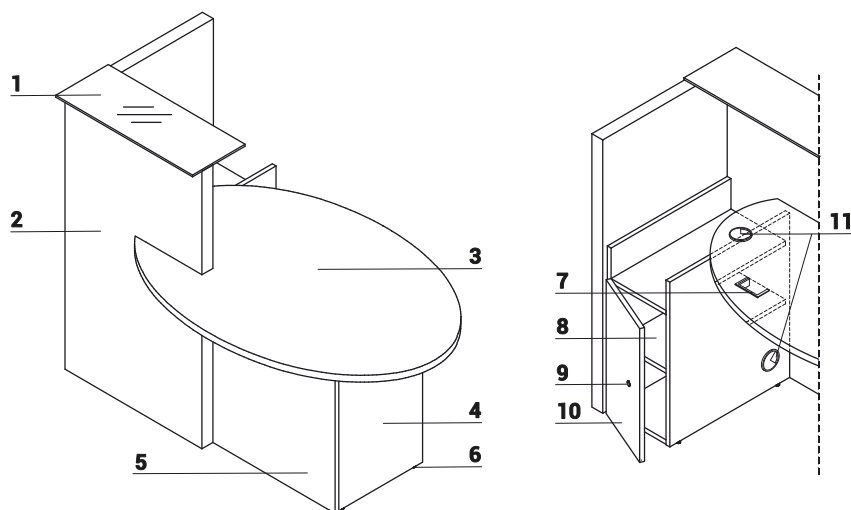
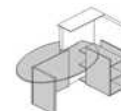

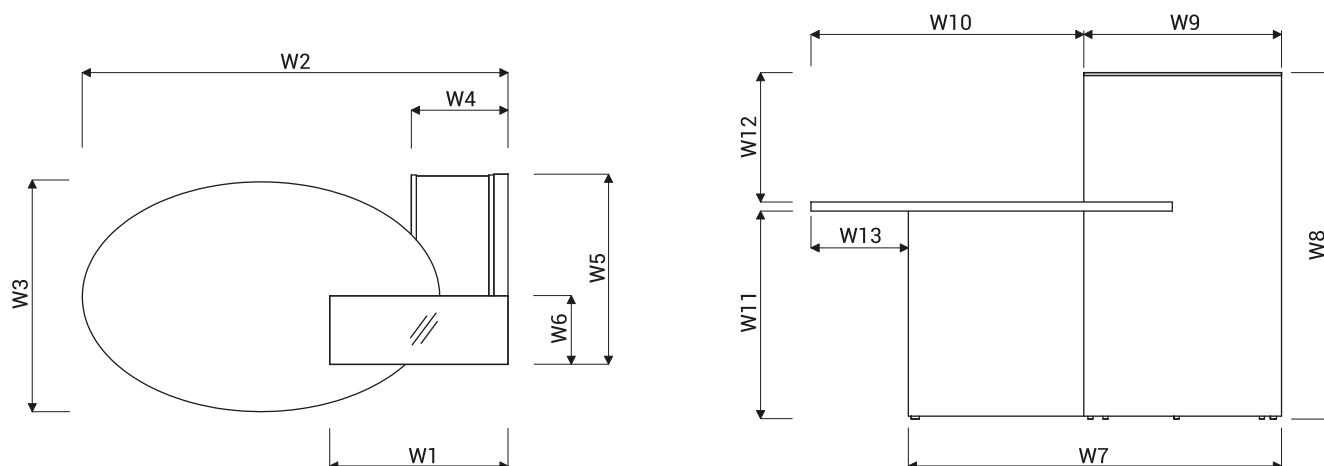

1. **Błat górny** - szkło hartowane, satynowane 8mm
2. **Front** - płyta melaminowana 52mm
3. **Błat roboczy** - płyta melaminowana 28mm, obrzeża PVC
4. **Korpus** - płyta melaminowana 28mm, obrzeża PVC
5. **Korpus** - płyta melaminowana 18mm, obrzeża PVC
6. **Regulator poziomy** - regulacja w zakresie 5mm
7. **Przepust kablowy prostokątny** - wymiary otworu 90x48 mm
8. **Regał wewnętrzny** - płyta melaminowana 18mm, obrzeża PVC
9. **Zamek patentowy**
10. **Front** - płyta melaminowana 18mm, obrzeża PVC
11. **Przepusty kablowe** - Ø80mm

## WYMIARY



W1 - 650mm | W2 - 1548mm | W3 - 870mm | W4 - 352mm | W5 - 695mm | W6 - 250mm | W7 - 1230mm | W8 - 1150mm | W9 - 650mm | W10 - 900mm | W11 - 692mm | W12 - 430mm | W13 - 320mm

WIDOK I RZUT OBIEKTU	WYMIARY [mm]			SYMBOL						UWAGI
	SZEROKOŚĆ	GŁĘBOKOŚĆ	WYSOKOŚĆ			kg	m3	szt		

## LADA OVO

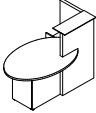
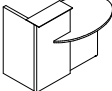
	1550	870	1150	<b>LOP10</b>		93.0	0.240	3		
	1550	870	1150	<b>LOL10</b>		93.0	0.236	3		

LEGENDA:

 - WAGA NETTO - OBJĘTOŚĆ - ILOŚĆ PACZEK