

## CARACTERÍSTICAS TÉCNICAS

### COLORES

#### ENCIMERA SUPERIOR - CRISTAL



BLANCO, LACOBEL



#### FRONTAL HPL



73 BLANCO BRILLO

74 NARANJA  
BRILLO

80 LIMA BRILLO

81 ROJO BURDEOS  
BRILLO

#### CUERPO

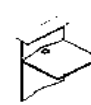
67 BLANCO  
PASTEL

#### PATA DE APOYO EN LA UNIÓN DE ENCIMERAS NL41

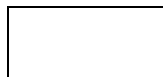
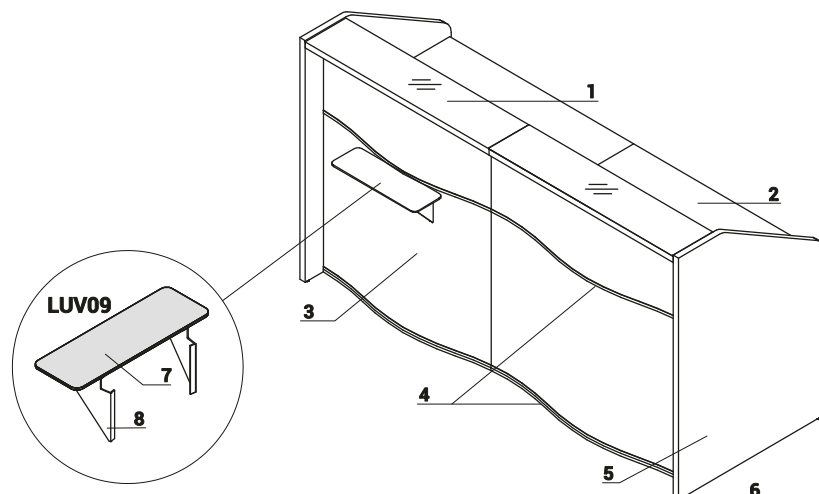
M015 BLANCO  
SEMI-MATE

1. Encimera - MFC 36mm con cristal LACOBEL 4mm - se pide por separado
2. Encimera - MFC 28mm, cantos PVC - con o sin rebajes pasacables
3. Frontal - HPL brillo
4. Franja decorativa - PVC, color M009- aluminio semi-mate
5. Panel lateral bajo - MFC 28mm, cantos PVC
6. Nivelación - 0-20mm
7. Estante para mostrador de recepción, HPL mate 6mm
8. Elemento de fijación - metal lacado, color: M015- blanco semi-mate

## CARACTERÍSTICAS TÉCNICAS

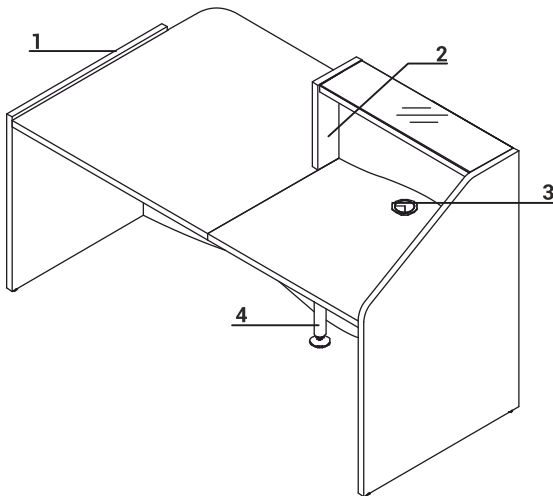

1. Panel lateral bajo - MFC 28mm, cantos PVC
2. Panel lateral de unión entre frentes bajos y altos - MFC 28mm, cantos PVC
3. Tapones pasacables - Ø80mm
4. Pata de apoyo NL41 - necesaria en la unión de encimeras

ATENCIÓN - parte interior del frontal en blanco

## APLICACIÓN ELEMENTOS FINALES

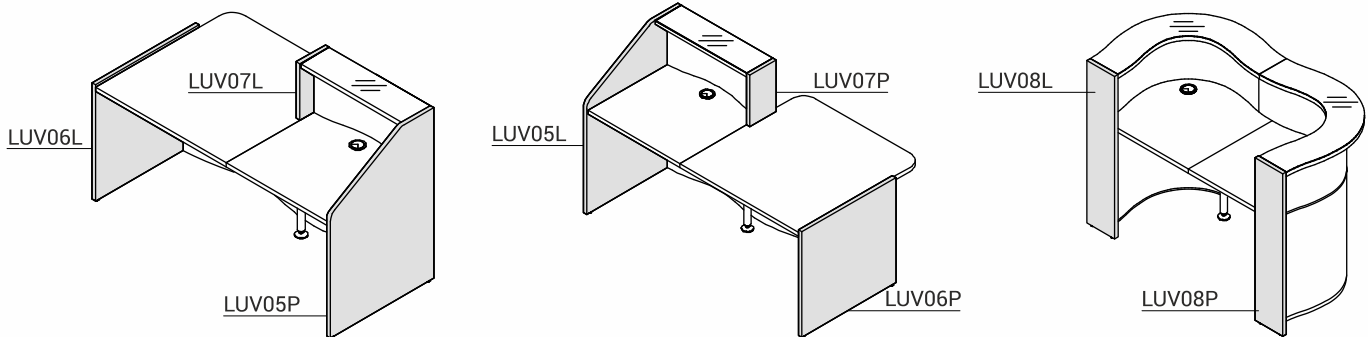

## DIMENSIONES

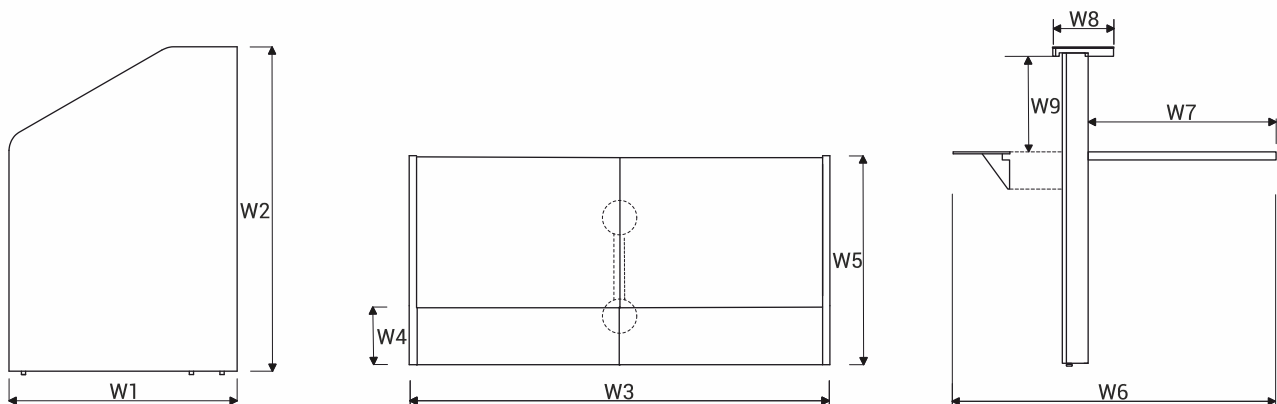

W1 - 770mm | W2 - 1103mm | W3 - 1556mm | W4 - 210mm | W5 - 770mm | W6 - 788mm | W7 - 650mm | W8 - 210mm | W9 - 330mm

SISTEMAS DE MOSTRADORES DE RECEPCIÓN

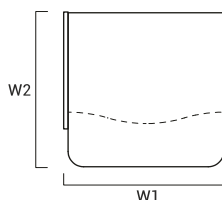
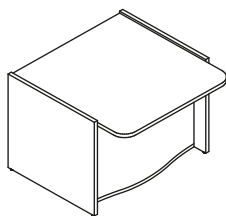

| REFERENCIA | DIMENSIONES [mm] |                |                |                |     |  | kg   | m3    | pcs |  | COMPONENTES          |
|------------|------------------|----------------|----------------|----------------|-----|--|------|-------|-----|--|----------------------|
|            | W <sub>1</sub>   | W <sub>2</sub> | D <sub>1</sub> | D <sub>2</sub> | H   |  |      |       |     |  |                      |
| LUV10      | 1026             | 1119           |                |                | 755 |  | 50.0 | 0.167 | 4   |  | LUV06L+LUV01+LUV06P  |
| LUV101     | 826              | 1119           |                |                | 755 |  | 44.0 | 0.141 | 4   |  | LUV06L+LUV011+LUV06P |

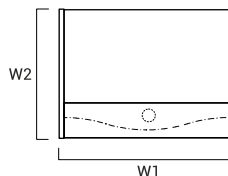
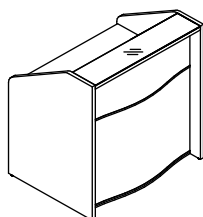

| REFERENCIA | DIMENSIONES [mm] |                |                |                |      |  | kg   | m3    | pcs |  | COMPONENTES         |
|------------|------------------|----------------|----------------|----------------|------|--|------|-------|-----|--|---------------------|
|            | W <sub>1</sub>   | W <sub>2</sub> | D <sub>1</sub> | D <sub>2</sub> | H    |  |      |       |     |  |                     |
| LUV11      | 806              | 770            |                |                | 1103 |  | 59.0 | 0.189 | 4   |  | LUV05L+LUV02+LUV05P |
| LUV12      | 1026             | 770            |                |                | 1103 |  | 63.0 | 0.226 | 4   |  | LUV05L+LUV03+LUV05P |

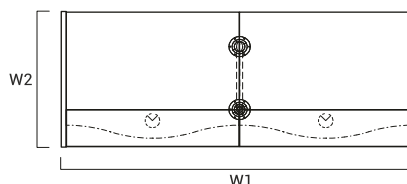
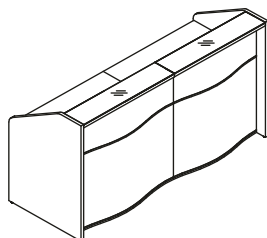

| REFERENCIA | DIMENSIONES [mm] |                |                |                |      |  | kg   | m3    | pcs |  | COMPONENTES                |
|------------|------------------|----------------|----------------|----------------|------|--|------|-------|-----|--|----------------------------|
|            | W <sub>1</sub>   | W <sub>2</sub> | D <sub>1</sub> | D <sub>2</sub> | H    |  |      |       |     |  |                            |
| LUV13      | 1556             | 770            |                |                | 1103 |  | 90.0 | 0.380 | 7   |  | LUV05L+2xLUV02+LUV05P+NL41 |
| LUV14      | 1996             | 770            |                |                | 1103 |  | 98.0 | 0.453 | 7   |  | LUV05L+2xLUV03+LUV05P+NL41 |

DESCRIPCIÓN:

- PESO NETO

- VOLUMEN

- NÚMERO DE PAQUETES

SISTEMAS DE MOSTRADORES DE RECEPCIÓN

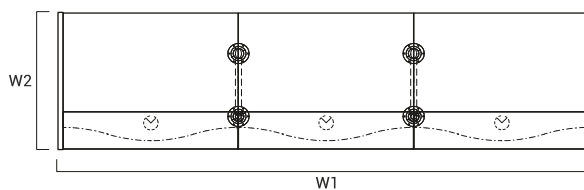
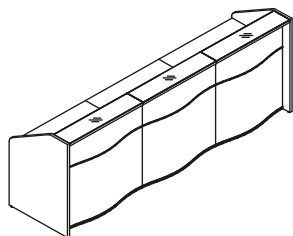

| REFERENCIA | DIMENSIONES [mm] |                |                |                |      |  | kg    | m3    | pcs | COMPONENTES                      |
|------------|------------------|----------------|----------------|----------------|------|--|-------|-------|-----|----------------------------------|
|            | W <sub>1</sub>   | W <sub>2</sub> | D <sub>1</sub> | D <sub>2</sub> | H    |  |       |       |     |                                  |
| LUV15      | 2306             | 770            |                |                | 1103 |  | 121.0 | 0.570 | 10  | LUV05L+3xLUV02+LUV05P<br>+2xNL41 |
| LUV16      | 2966             | 770            |                |                | 1103 |  | 133.0 | 0.681 | 10  | LUV05L+3xLUV03+LUV05P<br>+2xNL41 |

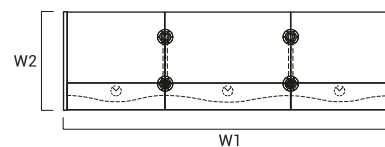
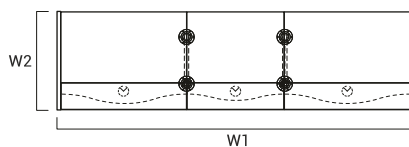
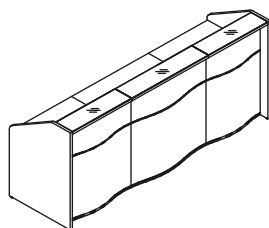

| REFERENCIA | DIMENSIONES [mm] |                |                |                |      |  | kg    | m3    | pcs | COMPONENTES                            |
|------------|------------------|----------------|----------------|----------------|------|--|-------|-------|-----|--|
|            | W <sub>1</sub>   | W <sub>2</sub> | D <sub>1</sub> | D <sub>2</sub> | H    |  |       |       |     |  |
| LUV17      | 2746             | 770            |                |                | 1103 |  | 129.0 | 0.644 | 10  | LUV05L+2xLUV02+LUV03<br>+LUV05P+2xNL41 |
| LUV18      | 2526             | 770            |                |                | 1103 |  | 125.0 | 0.607 | 10  | LUV05L+2xLUV03+LUV02<br>+LUV05P+2xNL41 |

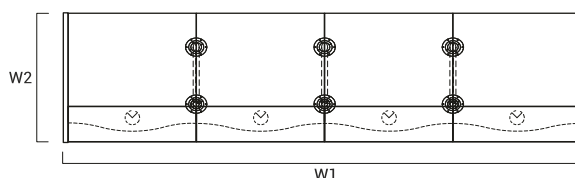
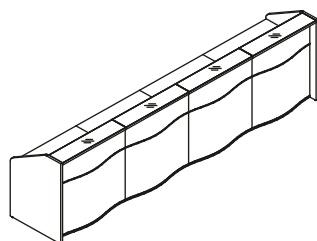

| REFERENCIA | DIMENSIONES [mm] |                |                |                |      |  | kg    | m3    | pcs | COMPONENTES                      |
|------------|------------------|----------------|----------------|----------------|------|--|-------|-------|-----|----------------------------------|
|            | W <sub>1</sub>   | W <sub>2</sub> | D <sub>1</sub> | D <sub>2</sub> | H    |  |       |       |     |                                  |
| LUV19      | 3496             | 770            |                |                | 1103 |  | 152.0 | 0.761 | 13  | LUV05L+4xLUV02+LUV05P<br>+3xNL41 |
| LUV20      | 3936             | 770            |                |                | 1103 |  | 168.0 | 0.909 | 13  | LUV05L+4xLUV03+LUV05P<br>+3xNL41 |

DESCRIPCIÓN:

- PESO NETO

- VOLUMEN

- NÚMERO DE PAQUETES

SISTEMAS DE MOSTRADORES DE RECEPCIÓN

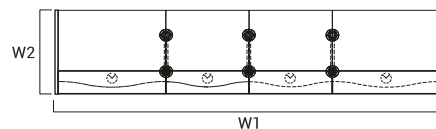
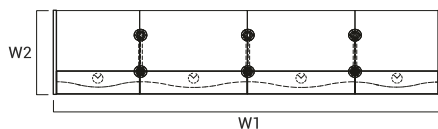
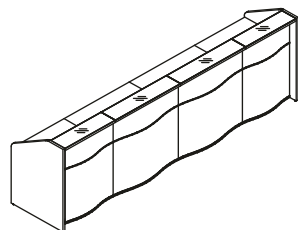

| REFERENCIA | DIMENSIONES [mm] |                |                |                |      |  | kg    | m3    | pcs | COMPONENTES                              |
|------------|------------------|----------------|----------------|----------------|------|--|-------|-------|-----|--|
|            | W <sub>1</sub>   | W <sub>2</sub> | D <sub>1</sub> | D <sub>2</sub> | H    |  |       |       |     |  |
| LUV21      | 3496             | 770            |                |                | 1103 |  | 160.0 | 0.835 | 13  | LUV05L+2xLUV02+2xLUV03<br>+LUV05P+3xNL41 |

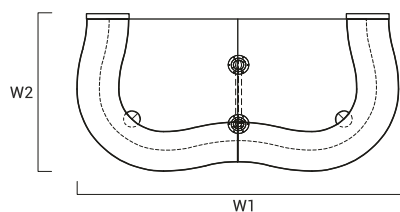
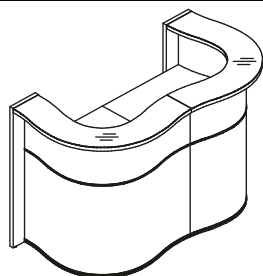

| REFERENCIA | DIMENSIONES [mm] |                |                |                |      |  | kg   | m3    | pcs | COMPONENTES                |
|------------|------------------|----------------|----------------|----------------|------|--|------|-------|-----|----------------------------|
|            | W <sub>1</sub>   | W <sub>2</sub> | D <sub>1</sub> | D <sub>2</sub> | H    |  |      |       |     |                            |
| LUV22      | 1624             | 841            |                |                | 1103 |  | 84.0 | 0.575 | 7   | LUV08L+2xLUV04+LUV08P+NL41 |

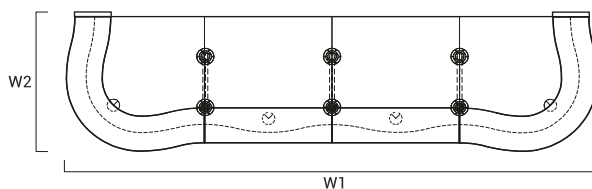
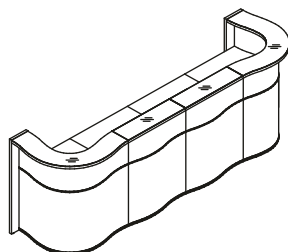

| REFERENCIA | DIMENSIONES [mm] |                |                |                |      |  | kg    | m3    | pcs | COMPONENTES                              |
|------------|------------------|----------------|----------------|----------------|------|--|-------|-------|-----|--|
|            | W <sub>1</sub>   | W <sub>2</sub> | D <sub>1</sub> | D <sub>2</sub> | H    |  |       |       |     |  |
| LUV23      | 3124             | 841            |                |                | 1103 |  | 146.0 | 0.957 | 13  | LUV08L+2xLUV04+2xLUV02<br>+LUV08P+3xNL41 |
| LUV24      | 3564             | 841            |                |                | 1103 |  | 154.0 | 1.031 | 13  | LUV08L+2xLUV04+2xLUV03<br>+LUV08P+3xNL41 |

DESCRIPCIÓN:

- PESO NETO

- VOLUMEN

- NÚMERO DE PAQUETES

SISTEMAS DE MOSTRADORES DE RECEPCIÓN

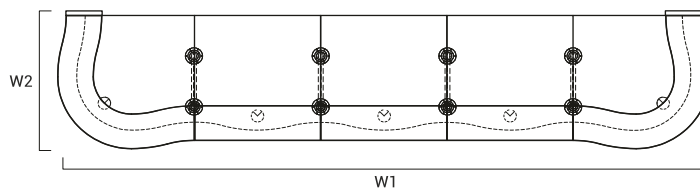
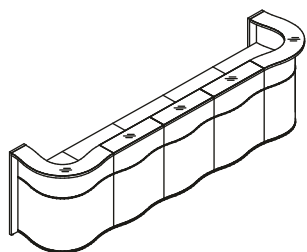

| REFERENCIA | DIMENSIONES [mm] |                |                |                |      |  | kg    | m3    | pcs | COMPONENTES                              |
|------------|------------------|----------------|----------------|----------------|------|--|-------|-------|-----|--|
|            | W <sub>1</sub>   | W <sub>2</sub> | D <sub>1</sub> | D <sub>2</sub> | H    |  |       |       |     |  |
| LUV25      | 3874             | 841            |                |                | 1103 |  | 177.0 | 1.148 | 16  | LUV08L+2xLUV04+3xLUV02<br>+LUV08P+4xNL41 |
| LUV26      | 4534             | 841            |                |                | 1103 |  | 189.0 | 1.259 | 16  | LUV08L+2xLUV04+3xLUV03<br>+LUV08P+4xNL41 |

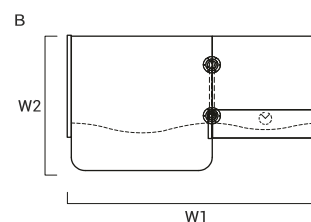
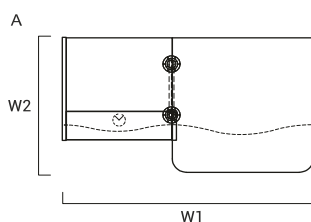
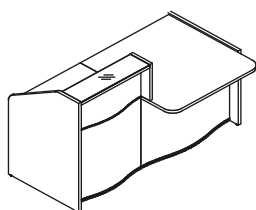

| REFERENCIA | DIMENSIONES [mm] |                |                |                |      |  | kg   | m3    | pcs | COMPONENTES                                |
|------------|------------------|----------------|----------------|----------------|------|--|------|-------|-----|--|
|            | W <sub>1</sub>   | W <sub>2</sub> | D <sub>1</sub> | D <sub>2</sub> | H    |  |      |       |     |  |
| A LUV27L   | 1776             | 1019           |                |                | 1103 |  | 87.0 | 0.368 | 8   | LUV06L+LUV01+LUV07L+LUV02<br>+LUV05P+NL41  |
| B LUV27P   | 1776             | 1019           |                |                | 1103 |  | 87.0 | 0.368 | 8   | LUV05L+LUV02+LUV07P+LUV01<br>+LUV06P+NL41  |
| A LUV271L  | 1576             | 1019           |                |                | 1103 |  | 81.0 | 0.342 | 8   | LUV06L+LUV011+LUV07L+LUV02<br>+LUV05P+NL41 |
| B LUV271P  | 1576             | 1019           |                |                | 1103 |  | 81.0 | 0.342 | 8   | LUV05L+LUV02+LUV07P+LUV011<br>+LUV06P+NL41 |
| A LUV28L   | 1996             | 1019           |                |                | 1103 |  | 91.0 | 0.405 | 8   | LUV06L+LUV01+LUV07L+LUV03<br>+LUV05P+NL41  |
| B LUV28P   | 1996             | 1019           |                |                | 1103 |  | 91.0 | 0.405 | 8   | LUV05L+LUV03+LUV07P+LUV01<br>+LUV06P+NL41  |
| A LUV281L  | 1776             | 1019           |                |                | 1103 |  | 85.0 | 0.379 | 8   | LUV06L+LUV011+LUV07L+LUV03<br>+LUV05P+NL41 |
| B LUV281P  | 1776             | 1019           |                |                | 1103 |  | 85.0 | 0.379 | 8   | LUV05L+LUV03+LUV07P+LUV011<br>+LUV06P+NL41 |

DESCRIPCIÓN:

- PESO NETO

- VOLUMEN

- NÚMERO DE PAQUETES

SISTEMAS DE MOSTRADORES DE RECEPCIÓN

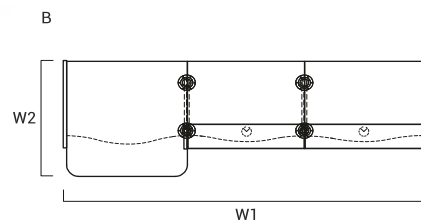
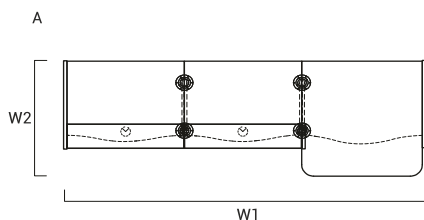
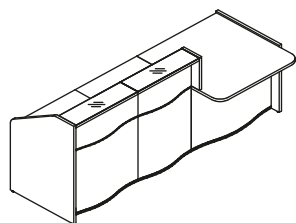

| REFERENCIA | DIMENSIONES [mm] |                |                |                |      | kg    | m3    | pcs | COMPONENTES                              |
|------------|------------------|----------------|----------------|----------------|------|-------|-------|-----|--|
|            | W <sub>1</sub>   | W <sub>2</sub> | D <sub>1</sub> | D <sub>2</sub> | H    |       |       |     |  |
| A LUV29L   | 2526             | 1019           |                |                | 1103 | 118.0 | 0.559 | 11  | LUV06L+LUV01+LUV07L+2xLUV02+LUV05P+NL41  |
| B LUV29P   | 2526             | 1019           |                |                | 1103 | 118.0 | 0.559 | 11  | LUV05L+2xLUV02+LUV07P+LUV01+LUV06P+NL41  |
| A LUV291L  | 2326             | 1019           |                |                | 1103 | 112.0 | 0.533 | 11  | LUV06L+LUV011+LUV07L+2xLUV03+LUV05P+NL41 |
| B LUV291P  | 2326             | 1019           |                |                | 1103 | 112.0 | 0.533 | 11  | LUV05L+2xLUV02+LUV07P+LUV011+LUV06P+NL41 |
| A LUV30L   | 2966             | 1019           |                |                | 1103 | 126.0 | 0.633 | 11  | LUV06L+LUV01+LUV07L+2xLUV03+LUV05P+NL41  |
| B LUV30P   | 2966             | 1019           |                |                | 1103 | 126.0 | 0.633 | 11  | LUV05L+2xLUV03+LUV07P+LUV01+LUV06P+NL41  |
| A LUV301L  | 2766             | 1019           |                |                | 1103 | 120.0 | 0.607 | 11  | LUV06L+LUV011+LUV07L+2xLUV03+LUV05P+NL41 |
| B LUV301P  | 2766             | 1019           |                |                | 1103 | 120.0 | 0.607 | 11  | LUV05L+2xLUV03+LUV07P+LUV011+LUV06P+NL41 |

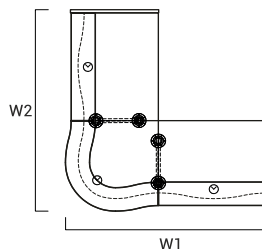
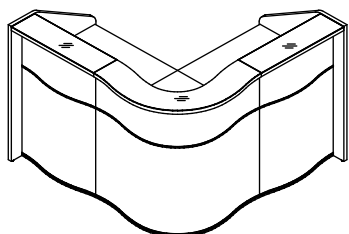

| REFERENCIA | DIMENSIONES [mm] |                |                |                |      | kg    | m3    | pcs | COMPONENTES                            |
|------------|------------------|----------------|----------------|----------------|------|-------|-------|-----|--|
|            | W <sub>1</sub>   | W <sub>2</sub> | D <sub>1</sub> | D <sub>2</sub> | H    |       |       |     |  |
| LUV35      | 1590             | 1590           |                |                | 1103 | 128.0 | 0.689 | 10  | LUV05L+LUV02+LUV04+LUV02+LUV05P+2xNL41 |
| LUV36      | 1810             | 1810           |                |                | 1103 | 136.0 | 0.763 | 10  | LUV05L+LUV03+LUV04+LUV03+LUV05P+2xNL41 |

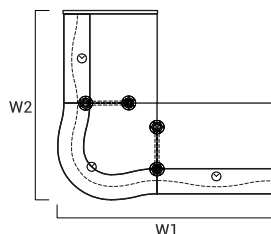
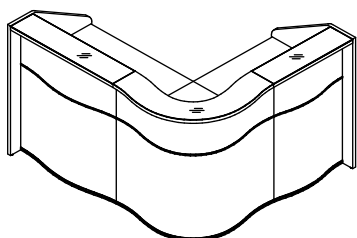

| REFERENCIA | DIMENSIONES [mm] |                |                |                |      | kg    | m3    | pcs | COMPONENTES                            |
|------------|------------------|----------------|----------------|----------------|------|-------|-------|-----|--|
|            | W <sub>1</sub>   | W <sub>2</sub> | D <sub>1</sub> | D <sub>2</sub> | H    |       |       |     |  |
| LUV37      | 1810             | 1590           |                |                | 1103 | 132.0 | 0.726 | 10  | LUV05L+LUV03+LUV04+LUV02+LUV05P+2xNL41 |

DESCRIPCIÓN:

- PESO NETO

- VOLUMEN

- NÚMERO DE PAQUETES

SISTEMAS DE MOSTRADORES DE RECEPCIÓN

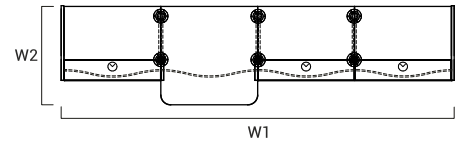
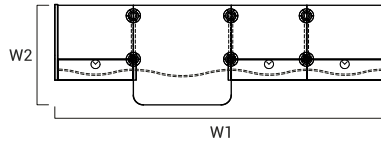
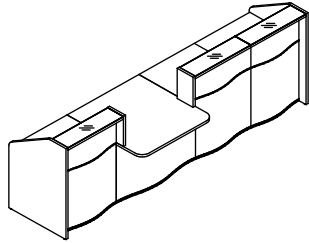

| REFERENCIA | DIMENSIONES [mm] |                |                |                |      |  | kg    | m3    | pcs | COMPONENTES  |
|------------|------------------|----------------|----------------|----------------|------|--|-------|-------|-----|--|
|            | W <sub>1</sub>   | W <sub>2</sub> | D <sub>1</sub> | D <sub>2</sub> | H    |  |       |       |     |  |
| LUV31      | 3276             | 1019           |                |                | 1103 |  | 155.0 | 0.759 | 15  | LUV05L+2xLUV02+LUV07P+LUV01+LUV07L+LUV02+LUV05P+3xNL41   |
| LUV311     | 3076             | 1019           |                |                | 1103 |  | 149.0 | 0.733 | 15  | LUV05L+2xLUV02+LUV07P+LUV011+LUV07L+LUV02+LUV05P+3xNI 41 |
| LUV32      | 3936             | 1019           |                |                | 1103 |  | 167.0 | 0.870 | 15  | LUV05L+2xLUV03+LUV07P+LUV01+LUV07L+LUV03+LUV05P+3xNL41   |
| LUV321     | 3736             | 1019           |                |                | 1103 |  | 161.0 | 0.844 | 15  | LUV05L+2xLUV03+LUV07P+LUV011+LUV07L+LUV03+LUV05P+3xNL41  |

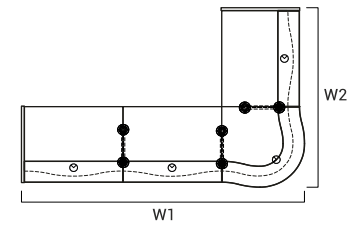
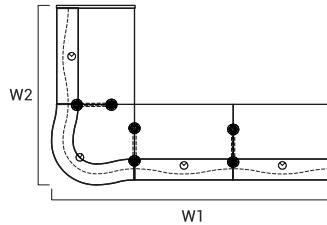
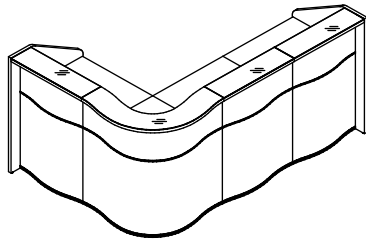

| REFERENCIA | DIMENSIONES [mm] |                |                |                |      |  | kg    | m3    | pcs | COMPONENTES                              |
|------------|------------------|----------------|----------------|----------------|------|--|-------|-------|-----|--|
|            | W <sub>1</sub>   | W <sub>2</sub> | D <sub>1</sub> | D <sub>2</sub> | H    |  |       |       |     |  |
| LUV41      | 2340             | 1590           |                |                | 1103 |  | 159.0 | 0.879 | 13  | LUV05L+2xLUV02+LUV04+LUV02+LUV05P+3xNL41 |
| LUV42      | 2780             | 1810           |                |                | 1103 |  | 171.0 | 0.990 | 13  | LUV05L+2xLUV03+LUV04+LUV03+LUV05P+3xNL41 |

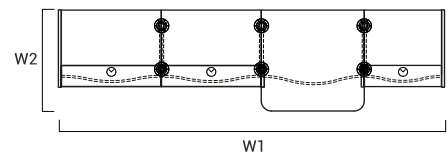
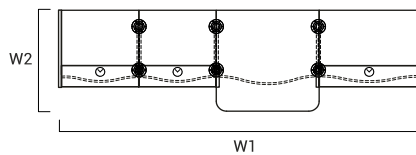
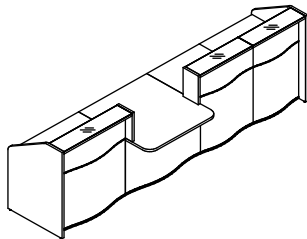

| REFERENCIA | DIMENSIONES [mm] |                |                |                |      |  | kg    | m3    | pcs | COMPONENTES   |
|------------|------------------|----------------|----------------|----------------|------|--|-------|-------|-----|---|
|            | W <sub>1</sub>   | W <sub>2</sub> | D <sub>1</sub> | D <sub>2</sub> | H    |  |       |       |     |   |
| LUV33      | 3496             | 1019           |                |                | 1103 |  | 159.0 | 0.796 | 15  | LUV05L+LUV03+LUV07P+LUV01+LUV07L+2xLUV02+LUV05P+3xNL41  |
| LUV331     | 3296             | 1019           |                |                | 1103 |  | 153.0 | 0.770 | 15  | LUV05L+LUV03+LUV07P+LUV011+LUV07L+2xLUV02+LUV05P+3xNL41 |
| LUV34      | 3716             | 1019           |                |                | 1103 |  | 163.0 | 0.833 | 15  | LUV05L+LUV02+LUV07P+LUV01+LUV07L+2xLUV03+LUV05P+3xNI 41 |
| LUV341     | 3516             | 1019           |                |                | 1103 |  | 157.0 | 0.807 | 15  | LUV05L+LUV02+LUV07P+LUV011+LUV07L+2xLUV03+LUV05P+3xNL41 |

DESCRIPCIÓN:

- PESO NETO

- VOLUMEN

- NÚMERO DE PAQUETES



SISTEMAS DE MOSTRADORES DE RECEPCIÓN

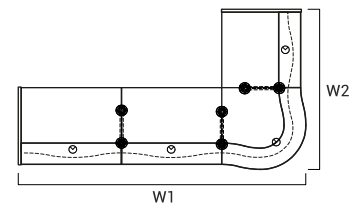
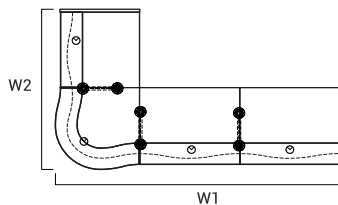
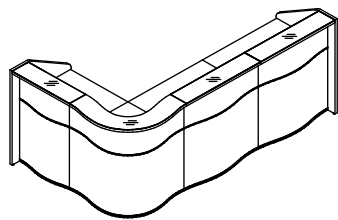

| REFERENCIA | DIMENSIONES [mm] |                |                |                |      |  | kg    | m3    | pcs | COMPONENTES                                  |
|------------|------------------|----------------|----------------|----------------|------|--|-------|-------|-----|--|
|            | W <sub>1</sub>   | W <sub>2</sub> | D <sub>1</sub> | D <sub>2</sub> | H    |  |       |       |     |  |
| LUV43      | 2780             | 1591           |                |                | 1103 |  | 167.0 | 0.953 | 13  | LUV05L+2xLUV03+LUV04+LUV02<br>+LUV05P+3xNL41 |
| LUV44      | 2343             | 1813           |                |                | 1103 |  | 163.0 | 0.916 | 13  | LUV05L+2xLUV02+LUV04+LUV03<br>+LUV05P+3xNL41 |

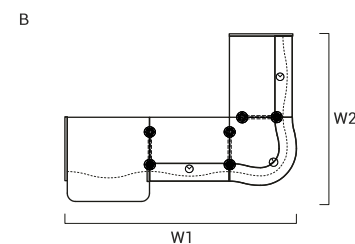
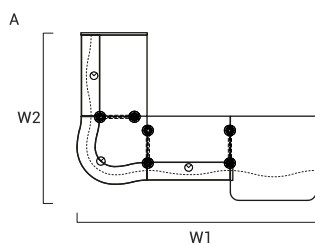
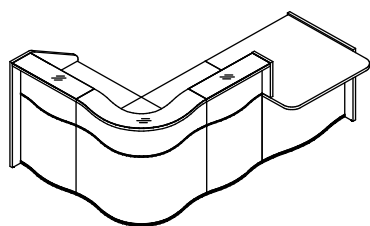

| REFERENCIA | DIMENSIONES [mm] |                |                |                |      |  | kg    | m3    | pcs | COMPONENTES  |
|------------|------------------|----------------|----------------|----------------|------|--|-------|-------|-----|--|
|            | W <sub>1</sub>   | W <sub>2</sub> | D <sub>1</sub> | D <sub>2</sub> | H    |  |       |       |     |  |
| A LUV38L   | 2560             | 1590           |                |                | 1103 |  | 156.0 | 0.868 | 14  | LUV06L+LUV01+LUV07L<br>+LUV02+LUV04+LUV02+LUV05P<br>+3xNL41  |
| B LUV38P   | 2560             | 1590           |                |                | 1103 |  | 156.0 | 0.868 | 14  | LUV05L+LUV02+LUV04+LUV02<br>+LUV07P+LUV01+LUV06P+3xNL41      |
| A LUV381L  | 2360             | 1590           |                |                | 1103 |  | 150.0 | 0.842 | 14  | LUV06L+LUV011+LUV07L+LUV02<br>+LUV04+LUV02+LUV05P+3xNL41     |
| B LUV381P  | 2360             | 1590           |                |                | 1103 |  | 150.0 | 0.842 | 14  | LUV05L+LUV02+LUV04+LUV02<br>+LUV07P+LUV011+LUV06P<br>+3xNL41 |
| A LUV39L   | 2780             | 1810           |                |                | 1103 |  | 164.0 | 0.942 | 14  | LUV06L+LUV01+LUV07L+LUV03<br>+LUV04+LUV03+LUV05P+3xNL41      |
| B LUV39P   | 2780             | 1810           |                |                | 1103 |  | 164.0 | 0.942 | 14  | LUV05L+LUV03+LUV04+LUV03<br>+LUV07P+LUV01+LUV06P+3xNL41      |
| A LUV391L  | 2580             | 1810           |                |                | 1103 |  | 158.0 | 0.916 | 14  | LUV06L+LUV011+LUV07L+LUV03<br>+LUV04+LUV03+LUV05P+3xNL41     |
| B LUV391P  | 2580             | 1810           |                |                | 1103 |  | 158.0 | 0.916 | 14  | LUV05L+LUV03+LUV04+LUV03<br>+LUV07P+LUV011+LUV06P<br>+3xNL41 |

DESCRIPCIÓN:

- PESO NETO

- VOLUMEN

- NÚMERO DE PAQUETES

SISTEMAS DE MOSTRADORES DE RECEPCIÓN

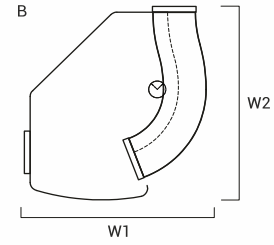
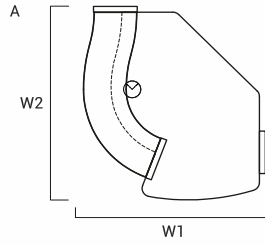
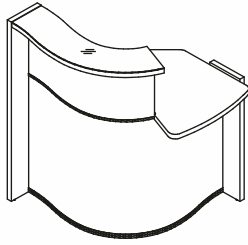

| REFERENCIA      | DIMENSIONES [mm] |                |                |                |      |  | kg   | m3    | pcs | COMPONENTES |
|-----------------|------------------|----------------|----------------|----------------|------|--|------|-------|-----|-------------|
|                 | W <sub>1</sub>   | W <sub>2</sub> | D <sub>1</sub> | D <sub>2</sub> | H    |  |      |       |     |             |
| A <b>LUV49L</b> | 858              | 925            |                |                | 1103 |  | 39.0 | 0.231 | 2   |             |
| B <b>LUV49P</b> | 858              | 925            |                |                | 1103 |  | 39.0 | 0.231 | 2   |             |

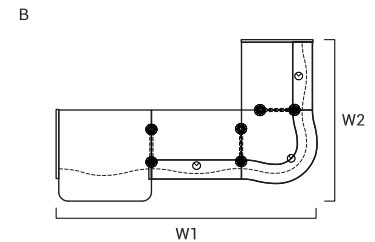
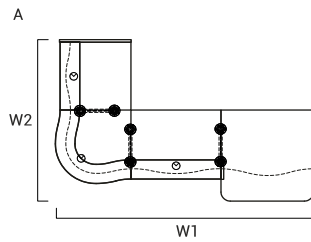
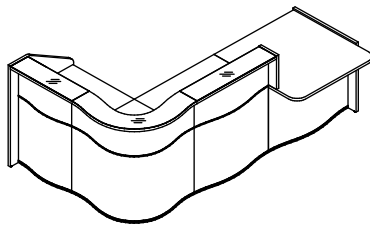

| REFERENCIA       | DIMENSIONES [mm] |                |                |                |      |  | kg    | m3    | pcs | COMPONENTES  |
|------------------|------------------|----------------|----------------|----------------|------|--|-------|-------|-----|--|
|                  | W <sub>1</sub>   | W <sub>2</sub> | D <sub>1</sub> | D <sub>2</sub> | H    |  |       |       |     |  |
| A <b>LUV40L</b>  | 2780             | 1792           |                |                | 1103 |  | 160.0 | 0.905 | 14  | LUV06L+LUV01+LUV07L+LUV03+LUV04+LUV02+LUV05P+3xNL41  |
| B <b>LUV40P</b>  | 2780             | 1792           |                |                | 1103 |  | 160.0 | 0.905 | 14  | LUV05L+LUV02+LUV04+LUV03+LUV07P+LUV01+LUV06P+3xNL41  |
| A <b>LUV401L</b> | 2580             | 1792           |                |                | 1103 |  | 154.0 | 0.879 | 14  | LUV06L+LUV011+LUV07L+LUV03+LUV04+LUV02+LUV05P+3xNL41 |
| B <b>LUV401P</b> | 2580             | 1792           |                |                | 1103 |  | 154.0 | 0.879 | 14  | LUV05L+LUV02+LUV04+LUV03+LUV07P+LUV011+LUV06P+3xNL41 |

DESCRIPCIÓN:

- PESO NETO

- VOLUMEN

- NÚMERO DE PAQUETES

SISTEMAS DE MOSTRADORES DE RECEPCIÓN

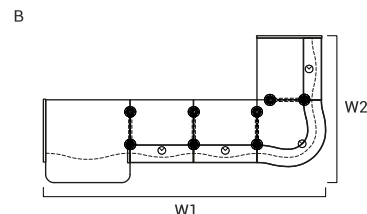
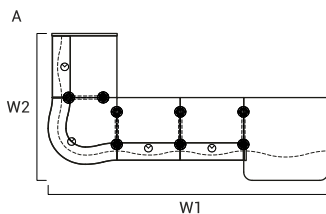
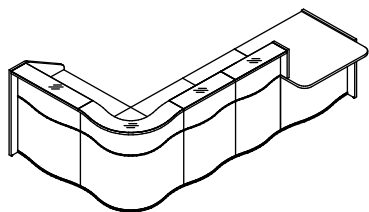

| REFERENCIA | DIMENSIONES [mm] |                |                |                |      | kg    | m3    | pcs | COMPONENTES  |
|------------|------------------|----------------|----------------|----------------|------|-------|-------|-----|--|
|            | W <sub>1</sub>   | W <sub>2</sub> | D <sub>1</sub> | D <sub>2</sub> | H    |       |       |     |  |
| A LUV45L   | 3310             | 1792           |                |                | 1103 | 187.0 | 1.059 | 17  | LUV06L+LUV01+LUV07L+2xLUV02+LUV04+LUV02+LUV05P+4xNL41  |
| B LUV45P   | 3310             | 1792           |                |                | 1103 | 187.0 | 1.059 | 17  | LUV05L+LUV02+LUV04+2xLUV02+LUV07P+LUV01+LUV06P+4xNL41  |
| A LUV451L  | 3110             | 1792           |                |                | 1103 | 181.0 | 1.033 | 17  | LUV06L+LUV011+LUV07L+2xLUV02+LUV04+LUV02+LUV05P+4xNL41 |
| B LUV451P  | 3110             | 1792           |                |                | 1103 | 181.0 | 1.033 | 17  | LUV05L+LUV02+LUV04+2xLUV02+LUV07P+LUV011+LUV06P+4xNL41 |
| A LUV46L   | 3750             | 1810           |                |                | 1103 | 199.0 | 1.169 | 17  | LUV06L+LUV01+LUV07L+2xLUV03+LUV04+LUV03+LUV05P+4xNL41  |
| B LUV46P   | 3750             | 1810           |                |                | 1103 | 199.0 | 1.169 | 17  | LUV05L+LUV03+LUV04+2xLUV03+LUV07P+LUV01+LUV06P+4xNL41  |
| A LUV461L  | 3550             | 1810           |                |                | 1103 | 193.0 | 1.144 | 17  | LUV06L+LUV011+LUV07L+2xLUV03+LUV04+LUV03+LUV05P+4xNL41 |
| B LUV461P  | 3750             | 1810           |                |                | 1103 | 193.0 | 1.144 | 17  | LUV05L+LUV03+LUV04+2xLUV03+LUV07P+LUV011+LUV06P+4xNL41 |

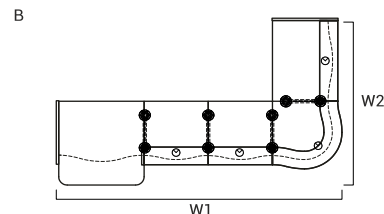
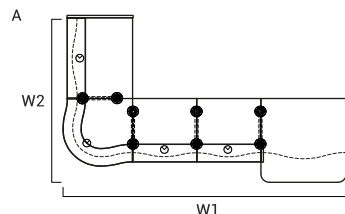
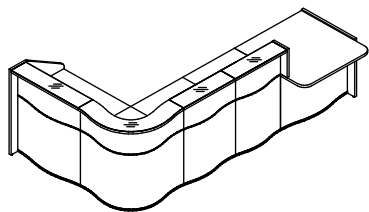



| REFERENCIA | DIMENSIONES [mm] |                |                |                |      | kg    | m3    | pcs | COMPONENTES  |
|------------|------------------|----------------|----------------|----------------|------|-------|-------|-----|--|
|            | W <sub>1</sub>   | W <sub>2</sub> | D <sub>1</sub> | D <sub>2</sub> | H    |       |       |     |  |
| A LUV47L   | 3310             | 1810           |                |                | 1103 | 195.0 | 1.133 | 17  | LUV06L+LUV01+LUV07L+2xLUV02+LUV04+LUV03+LUV05P+4xNL41  |
| B LUV47P   | 3310             | 1810           |                |                | 1103 | 195.0 | 1.133 | 17  | LUV05L+LUV03+LUV04+2xLUV02+LUV07P+LUV01+LUV06P+4xNL41  |
| A LUV471L  | 3110             | 1810           |                |                | 1103 | 189.0 | 1.107 | 17  | LUV06L+LUV011+LUV07L+2xLUV02+LUV04+LUV03+LUV05P+4xNL41 |
| B LUV471P  | 3110             | 1810           |                |                | 1103 | 189.0 | 1.107 | 17  | LUV05L+LUV03+LUV04+2xLUV02+LUV07P+LUV011+LUV06P+4xNL41 |
| A LUV48L   | 3750             | 1792           |                |                | 1103 | 191.0 | 1.096 | 17  | LUV06L+LUV01+LUV07L+2xLUV03+LUV04+LUV02+LUV05P+4xNL41  |
| B LUV48P   | 3750             | 1792           |                |                | 1103 | 191.0 | 1.096 | 17  | LUV05L+LUV02+LUV04+2xLUV03+LUV07P+LUV01+LUV06P+4xNL41  |
| A LUV481L  | 3550             | 1792           |                |                | 1103 | 185.0 | 1.070 | 17  | LUV06L+LUV011+LUV07L+2xLUV03+LUV04+LUV02+LUV05P+4xNL41 |
| B LUV481P  | 3550             | 1792           |                |                | 1103 | 185.0 | 1.070 | 17  | LUV05L+LUV02+LUV04+2xLUV03+LUV07P+LUV011+LUV06P+4xNL41 |

DESCRIPCIÓN:

- PESO NETO

- VOLUMEN

- NÚMERO DE PAQUETES

| ILUSTRACIÓN DE PRODUCTO | DIMENSIONES [mm] |             |        | REFERENCIA |  |  |  |  |  | COMPONENTES |
|-------------------------|------------------|-------------|--------|------------|--|---|---|---|--|-------------|
|                         | LARGO            | PROFUNDIDAD | ALTURA |            |  | kg  | m3  | pcs   |  |             |

ELEMENTOS DE COMPOSICIÓN

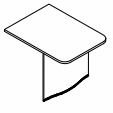
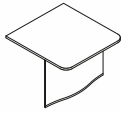
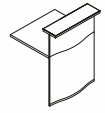
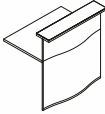
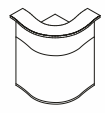
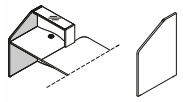
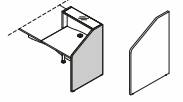
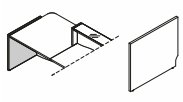
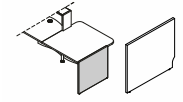
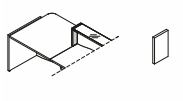
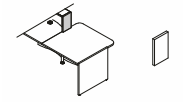

|   |     |      |      |        |  |      |       |   |  |           |
|---|-----|------|------|--------|--|------|-------|---|--|-----------|
|    | 750 | 1015 | 740  | LUV011 |  | 22.0 | 0.092 | 2 |  |           |
|    | 970 | 1015 | 740  | LUV01  |  | 28.0 | 0.118 | 2 |  |           |
|    | 750 | 763  | 1103 | LUV02  |  | 29.0 | 0.128 | 2 |  |           |
|    | 970 | 763  | 1103 | LUV03  |  | 33.0 | 0.165 | 2 |  |           |
|    | 815 | 815  | 1103 | LUV04  |  | 36.0 | 0.246 | 2 |  |           |
|  | 770 | 28   | 1103 | LUV05L |  | 15.0 | 0.030 | 1 |  | izquierda |
|  | 770 | 28   | 1103 | LUV05P |  | 15.0 | 0.030 | 1 |  | derecha   |
|  | 770 | 28   | 755  | LUV06L |  | 11.0 | 0.024 | 1 |  | izquierda |
|  | 770 | 28   | 755  | LUV06P |  | 11.0 | 0.024 | 1 |  | derecha   |
|  | 216 | 28   | 363  | LUV07L |  | 2.0  | 0.004 | 1 |  | izquierda |
|  | 216 | 28   | 363  | LUV07P |  | 2.0  | 0.004 | 1 |  | derecha   |

DESCRIPCIÓN:



 - PESO NETO

 - VOLUMEN

 - NÚMERO DE PAQUETES

| ILUSTRACIÓN DE PRODUCTO | DIMENSIONES [mm] |             |        | REFERENCIA |  |  |  |  |  | COMPONENTES |
|-------------------------|------------------|-------------|--------|------------|--|---|---|---|--|-------------|
|                         | LARGO            | PROFUNDIDAD | ALTURA |            |  | kg  | m3  | pcs   |  |             |

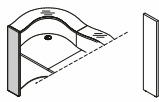
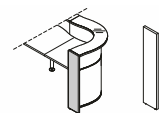
**ELEMENTOS DE COMPOSICIÓN**

|   |     |     |      |               |  |     |       |   |  |                        |
|---|-----|-----|------|---------------|--|-----|-------|---|--|------------------------|
|  | 216 | 28  | 1103 | <b>LUV08L</b> |  | 5.0 | 0.010 | 1 |  | izquierda              |
|  | 216 | 28  | 1103 | <b>LUV08P</b> |  | 5.0 | 0.010 | 1 |  | derecha                |
|  | 470 | 170 | 170  | <b>LUV09</b>  |  | 1.7 | 0.014 | 0 |  | 67-blanco pastel       |
|  | 585 | 142 | 712  | <b>NL41</b>   |  | 2.0 | 0.063 | 1 |  | pata de perfil redondo |

DESCRIPCIÓN:

 - PESO NETO

 - VOLUMEN

 - NÚMERO DE PAQUETES